

The logo for ZIEDEL is displayed in a bold, blue, sans-serif font. The letter 'E' in the middle is stylized with a white and orange geometric shape integrated into its center. The background of the entire page is a light blue and white pattern of various mechanical gears and gear teeth.

ZIEDEL

+91 84549 13166

sales@ziedel.com

<https://ziedel.com/>

DANDONG BOOST TURBO CO.LTD, 152-1, Jinshan Industrial Area, Guncheng
Village Xiangyang, Dandong City Liaoning Province, CHINA – 118100.

ZIEDEL



PRECISION TURBO SOLUTIONS FOR ENHANCED PERFORMANCE

Dandong Boost Turbo Power Co., Ltd., established in 2000, is a leading manufacturer specializing in high-precision turbo solutions. **Based in China**, we provide top-quality products to turbo re-manufacturers, repair specialists, and OEMs for their aftermarket turbo programs. Our extensive range includes turbocharger cores, turbine wheel shafts, compressor wheels, bearing housings, and more, all engineered and VSR balanced to ensure optimal performance. With advanced automation and strict quality control, we deliver reliable, high-performance solutions that meet the highest industry standards.

Our Product Range Includes:

Turbocharger CHRAs (Core Assemblies) Turbine Wheel Shafts	Compressor Wheels Bearing Housings	Seal Plates Heat Shields Variable Nozzle Rings
---	---------------------------------------	--

And much more...

+91 84549 13166

sales@ziedel.com

<https://ziedel.com/>

DANDONG BOOST TURBO CO.LTD, 152-1, Jinshan Industrial Area, Guncheng Village Xiangyang, Dandong City Liaoning Province, CHINA – 118100.

OUR PRODUCTS



ENGINE

VW T5 Transporter 2,5

OEM No.
070145701H

MODEL: GT2052V
PART NO. 720931-0003

Application
VW



ENGINE

MWM 4.10

OEM No.
80000172150

MODEL: TA31
PART NO. 465819

Application
VW



ENGINE

OEM No.
701855-5006S

MODEL: SJ50-1
PART NO.701855-5006S

Application
OHTERS



ENGINE

Tiggo 1.5L

OEM No.
E4T15B-1118010

MODEL: NGT13Z
PART NO.841084-5001

Application
OHTERS



ENGINE

Haima S5

OEM No.

MODEL: VT01
PART NO. 138000011

Application
OHTERS

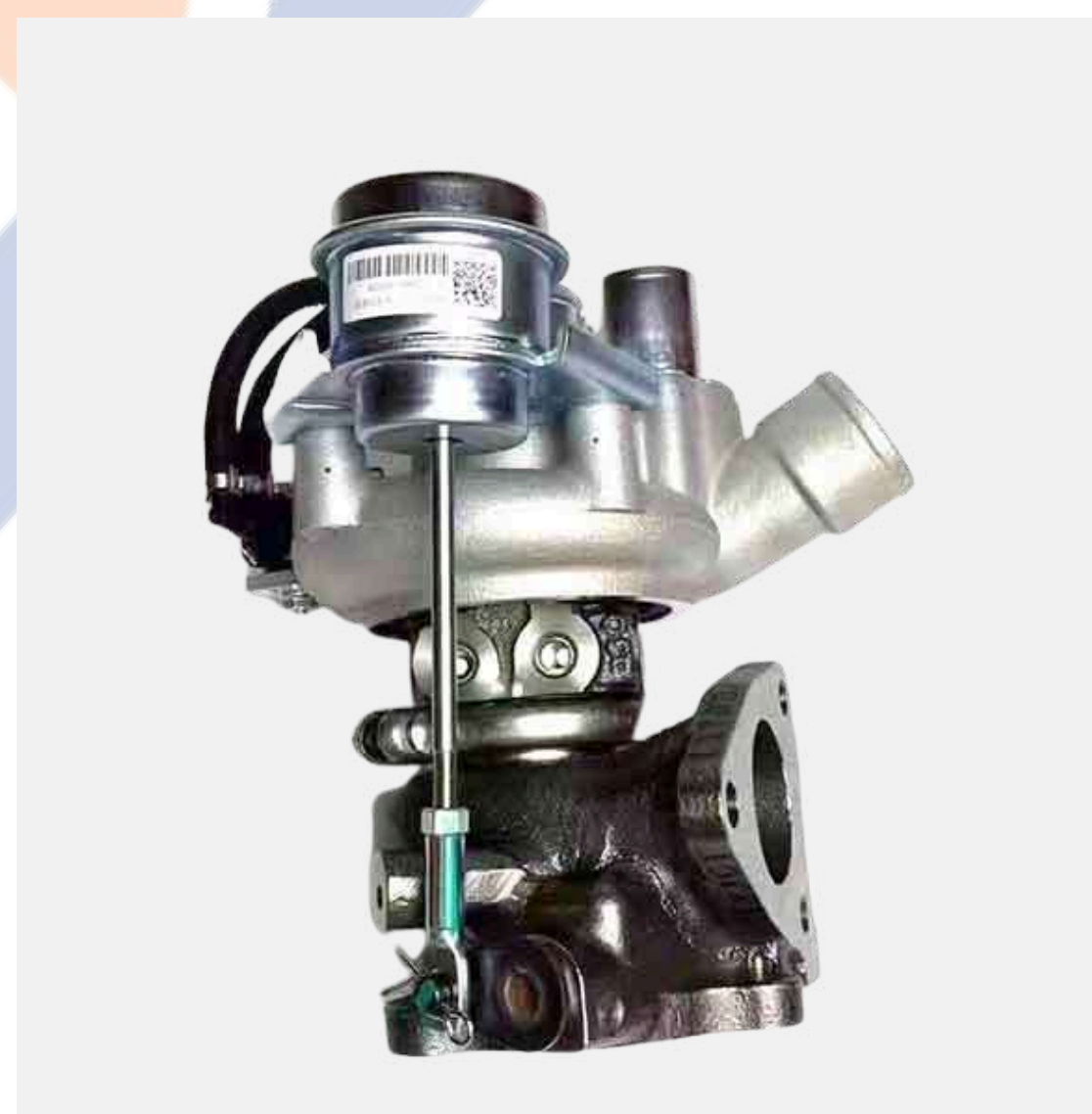

ENGINE

Haima S7

OEM No.
070145701H

MODEL: TF035
PART NO.49335-03210

Application
OHTERS



ENGINE

OPEL VECTRA C2.2DTI

OEM No.
705204-5002

MODEL: GT1849V
PART NO.717626-0001

Application
OPEL



ENGINE

132E10AL

OEM No.
1320900080

MODEL: TD025M1
PART NO.49173-02010

Application
SMART FORTWO

OUR PRODUCTS



ENGINE

Kyron2. 0L

OEM No.
A6640900780

MODEL: GTB1549V
PART NO.761433-0003

Application
SSANGYONG



ENGINE

Landcruiser4.2L

OEM No.
070145701H

MODEL: CT26
PART NO.17201-17030

Application
TOYOTA



ENGINE

PICNIC 3CTE

OEM No.

MODEL: CT9
PART NO .17201-64170

Application
TOYOTA



ENGINE

Previa 2L-T

OEM No.
070145701H

MODEL: CT9
PART NO. 17201-64030

Application
TOYOTA



ENGINE

1KD-FTV

OEM No.

MODEL: CT16V
PART NO. 17201-0L040

Application
TOYOTA



ENGINE

2-LT

OEM No.

MODEL: GT20
PART NO. 17201-54060

Application
TOYOTA



ENGINE

Crusier

OEM No.

MODEL: CT12B
PART NO. 17201-64090

Application
TOYOTA



ENGINE

Hiace 2L-T

OEM No.

MODEL: CT9
PART NO. 17201-64090

Application
TOYOTA

OUR PRODUCTS



ENGINE

FTA-2KD

OEM No.

MODEL: CT16
PART NO. 17201-30080

Application
TOYOTA



ENGINE

Hilux 15BFT

OEM No.

MODEL: CT12B
PART NO. 17201-58050

Application
TOYOTA



ENGINE

2GD-FTV

OEM No.

MODEL: CT16V
PART NO. 17201-11070

Application
TOYOTA



ENGINE

Celica

OEM No.
CT26-1

MODEL: CT26
PART NO.

Application
TOYOTA



ENGINE

Celica GT 4WD ST185
35-GTE

OEM No.

MODEL: CT26
PART NO. 17201-74010

Application
TOYOTA



ENGINE

2KD-FTV

OEM No.

MODEL: CT16
PART NO. 17201-30120

Application
TOYOTA



ENGINE

CT9

OEM No.

MODEL: CT12B
PART NO. 17201-64130

Application
TOYOTA



ENGINE

1VD-FTV

OEM No.

MODEL: VB22
PART NO. 17201-51020

Application
TOYOTA

OUR PRODUCTS



ENGINE

Earth Mowing 1004-4THR3

OEM No.
452073-5004S

MODEL: TB25
PART NO. 2674A056

Application
VOLVO



ENGINE

Shandra PO U101101
AL

OEM No.
701855-5006S

MODEL: GT1749V
PART NO. 701855-50065

Application
VW



ENGINE

Previa 2L-T

OEM No.

MODEL: CT26
PART NO. 17201-64030

Application
TOYOTA



ENGINE

Umwelt1.9L

OEM No.
028145701L

MODEL:
PART NO. 04E145722M

Application
VW

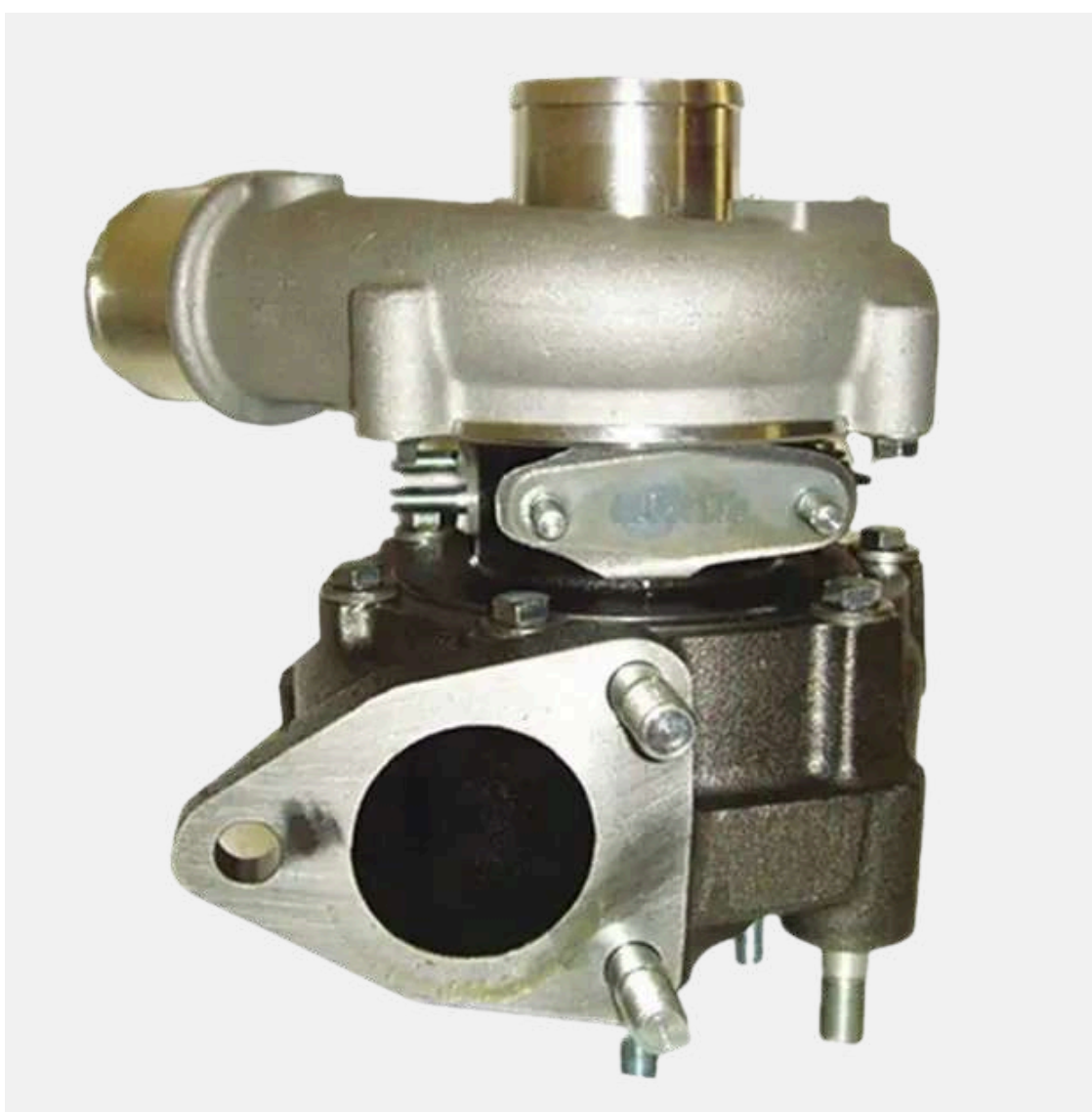

ENGINE

Aurs 100-FTV 1,2115HP

OEM No.
721164-0003

MODEL: GT1749V
PART NO. 17201-27030

Application
TOYOTA



ENGINE

JETTA MK7 1,4

OEM No.
04E145722

MODEL: GT20
PART NO. 17201-54060

Application
TOYOTA



ENGINE

MWM 4.07

OEM No.

MODEL: K14
PART NO. 905292010093

Application
VW



ENGINE

1KD-FTV

OEM No.

MODEL: CT16V
PART NO. 17201-0L040

Application
TOYOTA

OUR PRODUCTS



ENGINE

4 Runner 2LT,2-LT

OEM No.

MODEL: GT20
PART NO.17201-54030

Application
TOYOTA



ENGINE

12H-T, 1HDFT

OEM No.

MODEL: CT26
PART NO. 17201-68010

Application
TOYOTA



ENGINE

Articulated HaulerA40

OEM No.
2835376

MODEL: HE551
PART NO. 4042659

Application
VOLVO



ENGINE

Previa 2L-T

OEM No.
070145701H

MODEL: CT9
PART NO. 17201-64030

Application
TOYOTA



ENGINE

VW Golf TDI YUYLAJM

OEM No.
0382530419D

MODEL: GT1749V
PART NO. 713673-50065

Application
VW



ENGINE

8,150E

OEM No.
36145701

MODEL: GT1241Z
PART NO. 708001-0001

Application
TOYOTA



ENGINE

Parati Ea111

OEM No.
36145701

MODEL: GT1241Z
PART NO. 708001-0001

Application
VW



ENGINE

1VD-FTV

OEM No.

MODEL: VB23
PART NO. 17208-51010

Application
TOYOTA

OUR PRODUCTS



ENGINE

Trumpchi CS51.8T

OEM No.
5309880104

MODEL: K03
PART NO. 53039700288

Application
TRUMPCHI



ENGINE

Ford 2.0L

OEM No.
AG9N-6K682-AA

MODEL: K03
PART NO. 53039700288

Application
Volvo Ford Jaguar Land Rover



ENGINE

DV6B or DV6ATED4

OEM No.
9662371080

MODEL: TD025
PART NO. 49173-07508

Application
VOLVO



ENGINE

BUS TCD2013L6

OEM No.
316718

MODEL: S2B
PART NO.04253818KZ

Application
VOLVO



ENGINE

F12/N12/NL12

OEM No.
478794

MODEL: TA5102
PART NO. 466076-0002

Application
VOVLVO



ENGINE

Truck Volvo Fh12

OEM No.
8113407

MODEL: HX55
PART NO. 359177

Application
VOLVO



ENGINE

Liebherr D9

OEM No.
20738765

MODEL: K29
PART NO. 53299706913

Application
VOLVO



ENGINE

Laguna Megane SCBC VFQ

OEM No.
8200091350A

MODEL: GT1549
PART NO. 703245-0002

Application
VOLVO

OUR PRODUCTS



ENGINE

Truck F12/
N12TD122

OEM No.
478122

MODEL: H2D
PART NO. 3526008

Application
VOLVO



ENGINE

VI. 4TDC

OEM No.
54359700009

MODEL: KP35
PART NO. 54359700009

Application
CIRTOEN PEUGEOT



ENGINE

Citroen C 512.0HDI

OEM No.
9632124680

MODEL: K03
PART NO. 53039700050

Application
CITROEN



ENGINE

Circen Beringo 2.0 HDI
2.0L

OEM No.
9633382180

MODEL: K03
PART NO. 53039700009

Application
CITROEN



ENGINE

3116T

OEM No.
OR6744

MODEL: S2ESL105
PART NO. 167085

Application
CATERPILLAR



ENGINE

3306

OEM No.
7N7748

MODEL: 3LM
PART NO.310135

Application
CATERPILLAR



ENGINE

CAT3306

OEM No.
1W1227

MODEL: 4LF-302
PART NO. 1W93830

Application
CATERPILLAR



ENGINE

CAT3204T

OEM No.
4N6860

MODEL: TO4B91
PART NO. 408077-0001

Application
CATERPILLAR

OUR PRODUCTS



ENGINE

Wheel Loader Series
906F, Marine

OEM No.
OR6599

MODEL: S2E
PART NO. 100-5865

Application
CATERPILLAR



ENGINE

CAT3116

OEM No.
OR6865

MODEL: S2EGL112
PART NO. 105-5059

Application
CATERPILLAR



ENGINE

CAT 3126B

OEM No.
171564

MODEL: S300G071
PART NO. 191-8021

Application
CATERPILLAR



ENGINE

FORESTER58T EJ206

OEM No.
144112AA231

MODEL: CT9
PART NO.49377-04200

Application
SUBARU



ENGINE

Agricultural Engines
NB4L

OEM No.
VA420057

MODEL: RHF4
PART NO. 135756170

Application
SUBARU



ENGINE

Subaru Ej200

OEM No.
144112AA100

MODEL: TD04L-13G
PART NO. 49377-04000

Application
SUBARU



ENGINE

WRX Ej255

OEM No.
49477-04000

MODEL: TD04
PART NO. 14411-AA710

Application
SUBARU



ENGINE

Truck F12/ Works Ya

OEM No.
49477-04000

MODEL: CT9
PART NO. 14411-AA710

Application
SUZUKI

OUR PRODUCTS



ENGINE

YA1, F6AT, Isuzu 4TNA

OEM No.
1390062D51

MODEL: RHB31
PART NO.VE110069

Application
SUZUKI



ENGINE

Landcruiser 4.2L

OEM No.
070145701H

MODEL: CT26
PART NO.17201-17030

Application
TOYOTA



ENGINE

Grand Vitara

OEM No.
53039880051

MODEL: K03
PART NO. 53039700051

Application
SUZUKI

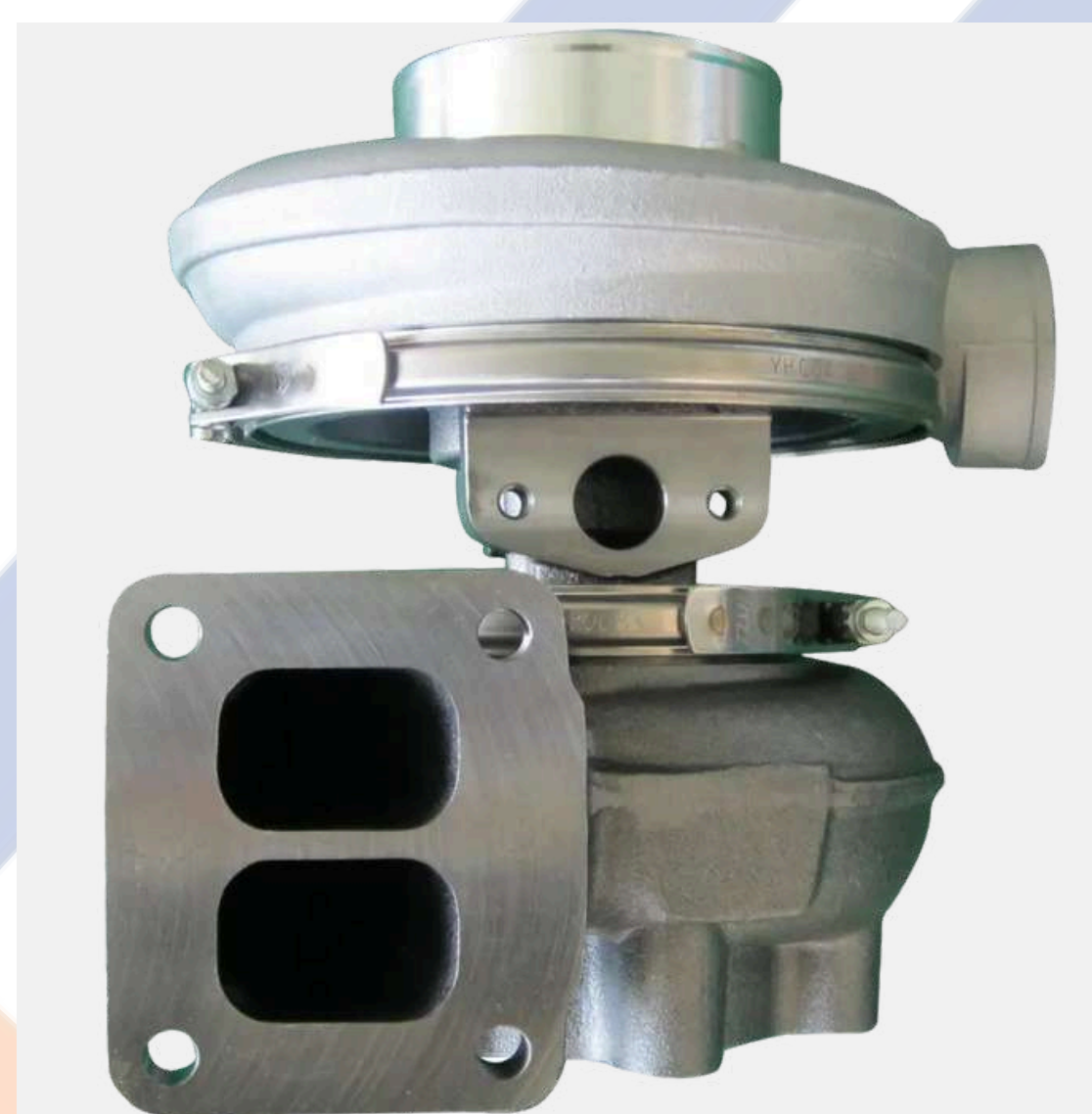

ENGINE

Truck DSC11-17

OEM No.
070145701H

MODEL: S3A
PART NO. 312267

Application
SCANIA



ENGINE

B205E 2.0L, 3.0L

OEM No.
5955703

MODEL: GT1852S
PART NO. 452204-5005S

Application
SAAB



ENGINE

Saab-3: Aero: Viggen

OEM No.

MODEL: TD04HL-15T
PART NO. 49189-01800

Application
SAAB



ENGINE

DW1ZUTED 22

OEM No.
9643350480

MODEL: K03
PART NO. 53039880062

Application
PEUGEOT



ENGINE

Peugeot 207 1.6

OEM No.

MODEL: K03
PART NO. 53039880425

Application
PEUGEOT

OUR PRODUCTS



ENGINE

Master M9T D3

OEM No.
8200823026

MODEL: GTB1549LV
PART NO. 790179-5002S

Application
PEUGEOT



ENGINE

MG ZT R75 1.8

OEM No.
070145701H

MODEL: GT2052GLS
PART NO. 765472-0001

Application
PEUGEOT



ENGINE

MIDR062045

OEM No.
5000681268

MODEL: H2C
PART NO. 3524695

Application
RENAULT



ENGINE

Turck6. 18L

OEM No.
5010450477

MODEL: S200
PART NO. 317980

Application
RENAULT



ENGINE

GrandSceniccio 1.46L

OEM No.
7701475135

MODEL: KP39
PART NO. 54399700027

Application
RENAULT



ENGINE

Clio 1.5L

OEM No.
8200022735

MODEL: KP35
PART NO. 54359880000

Application
RENAULT



ENGINE

1.9D

OEM No.
7700107795

MODEL: GT1544S
PART NO. 700830-0001

Application
RENAULT



ENGINE

Premium 11. 12L

MIDR062356

OEM No.
318294

MODEL: S400
PART NO. 5010412597

Application
RENAULT

OUR PRODUCTS

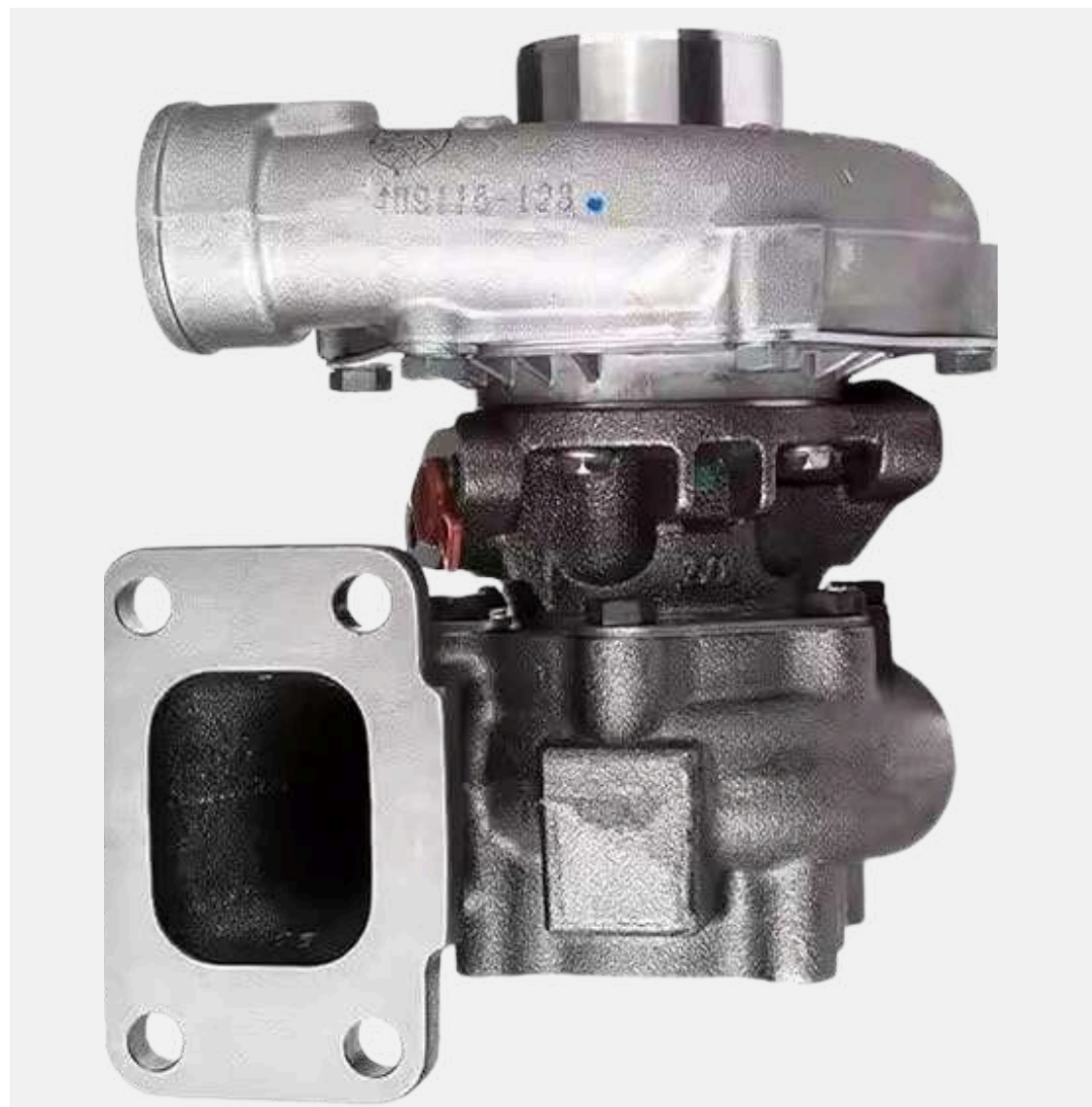

ENGINE

Traktor1104,
4400com
OEM No.
2674A200
MODEL: GT2556S
PART NO. 711736-0001
Application
PERKINS



ENGINE

Perkins1103A
OEM No.
2674A421
MODEL: CT26
PART NO. 754111-0007
Application
PERKINS



ENGINE

T3-152
OEM No.
311511
MODEL: S2A
PART NO. 2674A152
Application
PERKINS



ENGINE

industrial, Genset
1103A
OEM No.
2674A422
MODEL: GT2049S
PART NO. 754111-0009
Application
PERKINS



ENGINE

Phaser T4.404.0
OEM No.
2674A150
MODEL: TB2558
PART NO. 452065-5003
Application
PERKINS



ENGINE

2-LT
OEM No.
2674A095
MODEL: GT20
PART NO. 17201-54060
Application
PERKINS



ENGINE

Industrial varios 4.4L
OEM No.
2674A404
MODEL: GT25
PART NO. 758714-5001
Application
PERKINS



ENGINE

160T/T6-60cc/
T60354
OEM No.
315026
MODEL: S2B
PART NO. 2674A407
Application
PERKINS

OUR PRODUCTS



ENGINE

Perkins Industrial
1004 27
OEM No.
02/200310 2674399
MODEL: TA3123
PART NO. 466674-0001
Application
PERKINS



ENGINE

Various 4.4LTR
4400 ccm
OEM No.
2674A225
MODEL: GT2256S
PART NO. 711736-0025
Application
PERKINS



ENGINE

QD32
OEM No.
14411-7T600
MODEL: TD04L
PART NO. 49377-02600
Application
NISSAN



ENGINE

FAW Truck CA4DF2-13
OEM No.
070145701H
MODEL: GT2559S
PART NO. 730237-5009
Application
NISSAN



ENGINE

Nissan Dead Constution
Exipment
OEM No.
MODEL: HT18
PART NO. 14411-62T00
Application
NISSAN



ENGINE

Nissan Diesel Temano 3.2L
OEM No.
047-276
MODEL: HT12-11B
PART NO. 14411-1W402
Application
NISSAN

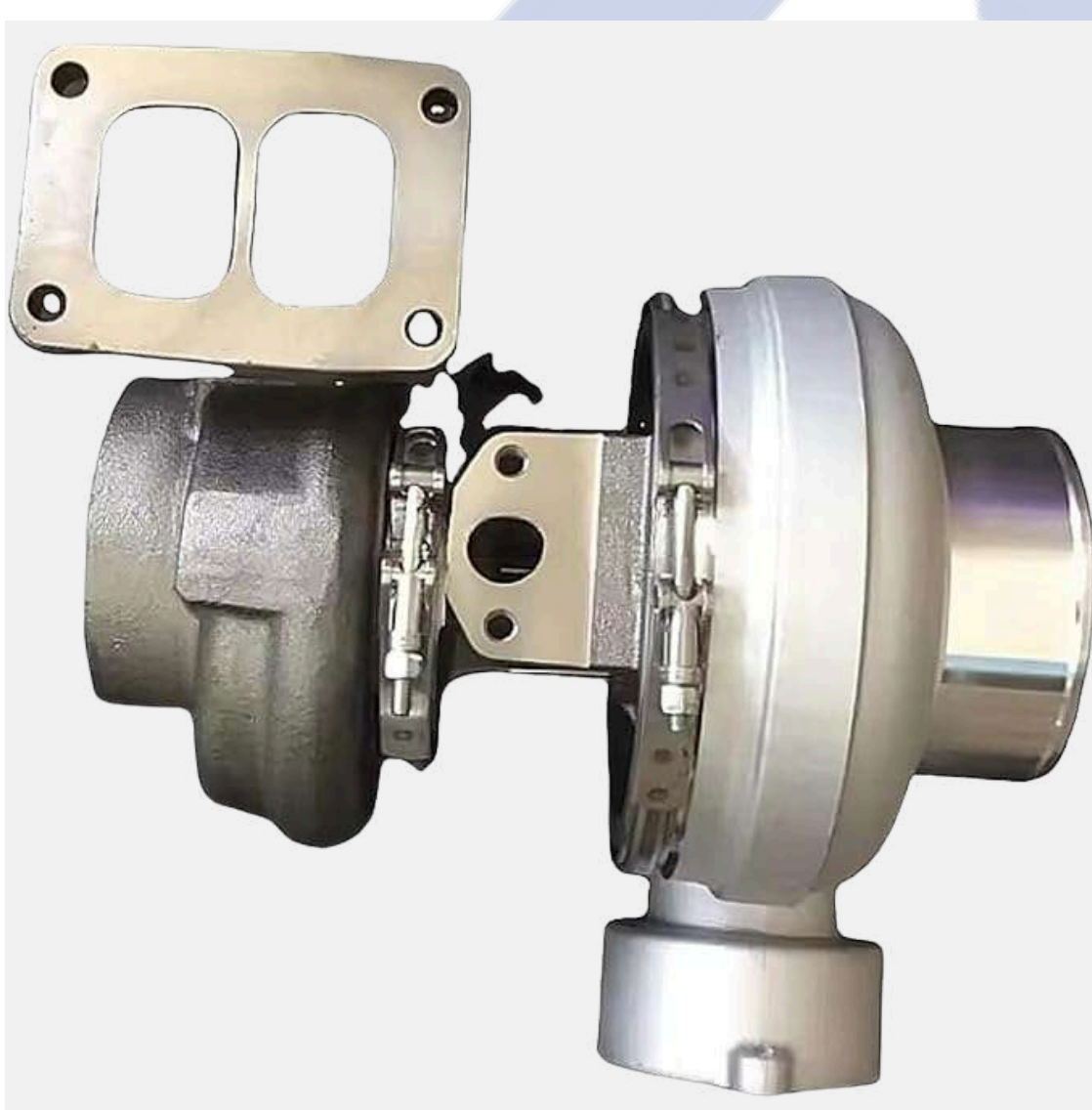

ENGINE

CAT3406, D8N
OEM No.
OR6333
MODEL: S4DS006
PART NO. 7C7691
Application
CATERPILLAR



ENGINE

CAT3116
OEM No.
OR6724
MODEL: CT9
PART NO. 103-0651
Application
CATERPILLAR

OUR PRODUCTS



ENGINE

CAT3306

OEM No.

MODEL: S3B
PART NO. 214-6914

Application
CATERPILLAR



ENGINE

CAT3116

OEM No.

MODEL: S2ESL001
PART NO.612278

Application
CATERPILLAR



ENGINE

CAT3406E

OEM No.
Or9928

MODEL: BTG7508
PART NO. 471120-5001S

Application
CATERPILLAR



ENGINE

BMW320D

OEM No.
11657794144

MODEL: GT1749V
PART NO. 750431-0001

Application
BMW



ENGINE

BMW318D

OEM No.

MODEL: GT1549V
PART NO.700447-0001

Application
BMW

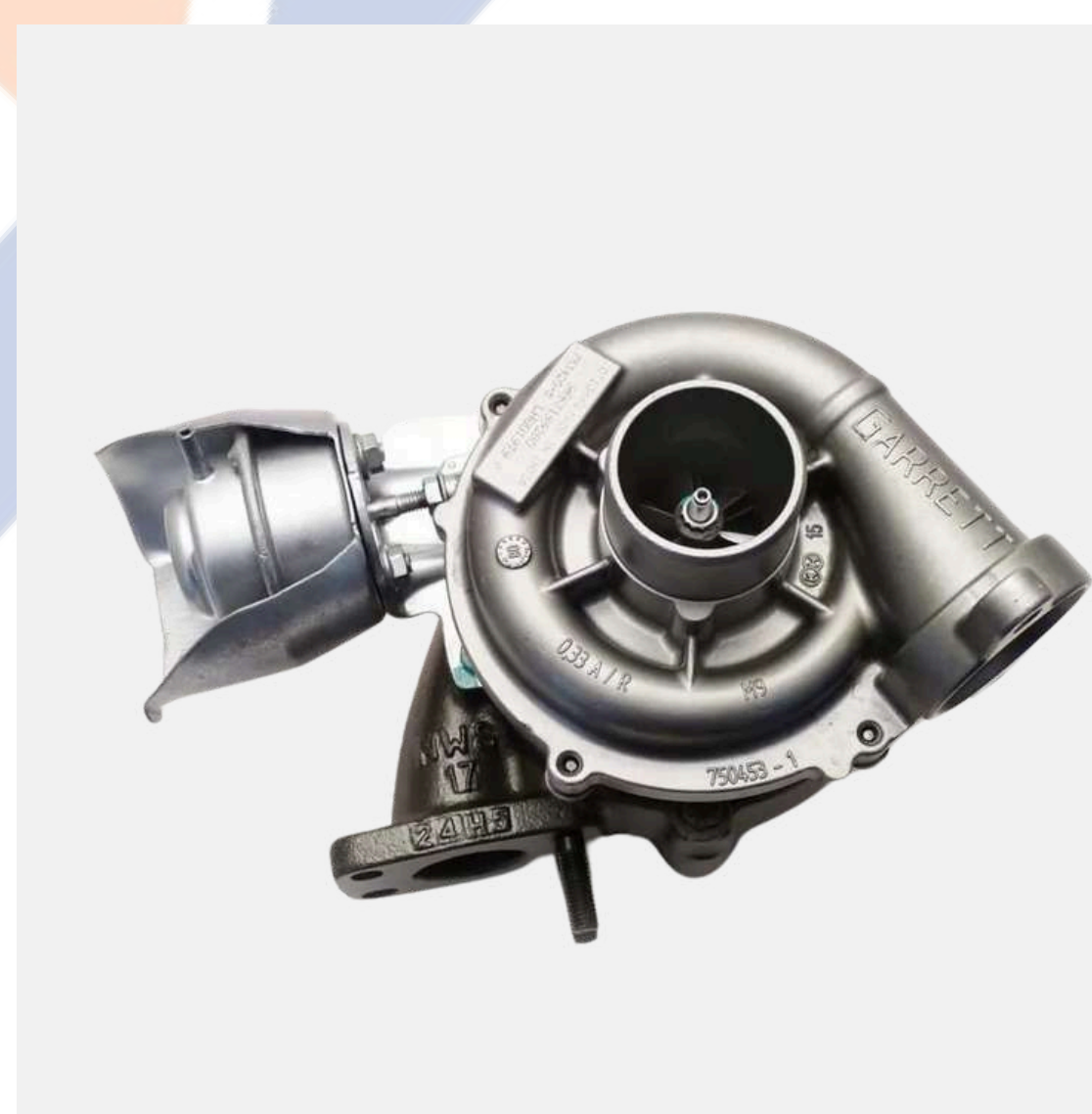

ENGINE

BMW MINI COOPER

OEM No.
740821-0001

MODEL: GT1544V
PART NO. 753420-0005S

Application
BMW



ENGINE

Valtra BF75, BL77,S1B

OEM No.
315920

MODEL:
PART NO. 315921

Application
BENZ



ENGINE

BF4M2012C

OEM No.
04258205KZ

MODEL:
PART NO. 318279

Application
BENZ

OUR PRODUCTS



ENGINE

Nissan Terrano ZD30ETI

OEM No.
14411-VC100

MODEL: GTB1549V
PART NO. 723739-0002

Application
NISSAN



ENGINE

Audi Wesen Teram TU
& Cassan 2.7

OEM No.
14411-G2407

MODEL: TB2580
PART NO. 703605-0003

Application
NISSAN



ENGINE

Safari, Patrol RD28T

OEM No.
701196-50078

MODEL: GT1752S
PART NO. 14411-VB300

Application
NISSAN



ENGINE

RD28T

OEM No.
14411-22J00

MODEL: TB2527
PART NO. 465941-0005

Application
NISSAN



ENGINE

Nissan Terrano 12.7D1

OEM No.
14411-7F411

MODEL: GT2052S
PART NO. 722687-50015

Application
NISSAN



ENGINE

X-Trail 2.2L YD22

OEM No.
Ve420051

MODEL: RHF4H
PART NO. 14411-8H800

Application
NISSAN



ENGINE

FE6TA

OEM No.
14201-Z5905

MODEL: GT3576DL
PART NO. 702172

Application
NISSAN



ENGINE

F046

OEM No.
14411-24D00

MODEL: TB25
PART NO. 471024

Application
NISSAN

OUR PRODUCTS



ENGINE

ZD30

OEM No.
14411-9S00A

MODEL: HT12-19B
PART NO. 14411-95300

Application
NISSAN



ENGINE

Nissan Navara 2.5DI

OEM No.
Vb420058

MODEL: RHF4H
PART NO. 14411-VK500

Application
NISSAN



ENGINE

Nissan Pathfinder
Qw25/yd25ddti

OEM No.
14411-EB300

MODEL: GT2056V
PART NO. 751243-0002

Application
NISSAN



ENGINE

Pathfinder, Navara
YD25DDT

OEM No.

MODEL: GT2056V
PART NO. 769708-0002

Application
NISSAN



ENGINE

Nissan Various
With NF6T

OEM No.
14201-00ZOD

MODEL: GT4594LR
PART NO. 763530-0001

Application
NISSAN



ENGINE

Nissan Qashqai
1.5DCI

OEM No.
54399880030

MODEL: BV39
PART NO. 54399700030

Application
NISSAN



ENGINE

Nissan Terrand Petol

OEM No.
14411-2W20A

MODEL: GT2052V
PART NO. 726442-0001

Application
NISSAN



ENGINE

Pine Lograte-100-P
1.1-1. AL

OEM No.
14411-2J600

MODEL: GT1548S
PART NO. 466755-0003

Application
NISSAN

OUR PRODUCTS



ENGINE

6D24

OEM No.
28200-84400

MODEL: TF08L-28M
PART NO. 49134-00272

Application
MITSUBISHI



ENGINE

Outlander 2.2

OEM No.
49335-01122

MODEL: TF035HL
PART NO. 1515A238

Application
MITSUBISHI



ENGINE

TRITON 4WD
4N152.4

OEM No.
49335-01410

MODEL: TF035
PART NO. 1515A295

Application
MITSUBISHI



ENGINE

Pajero L200

OEM No.
070145701H

MODEL: TF035HL2
PART NO. 49135-02652

Application
MITSUBISHI



ENGINE

1598CC14

OEM No.
1826344C91

MODEL: K03
PART NO. 53039880118

Application
MINI COOPER



ENGINE

DT466E

OEM No.
1826344C91

MODEL: GTA3776
PART NO. 751400-5001S

Application
NAVISTAR



ENGINE

D1466

OEM No.
1825476C92

MODEL: GT4082D
PART NO. 466743-0016

Application
NAVISTAR



ENGINE

Interstar 2.5 G9U

OEM No.
93161963

MODEL: K03
PART NO. 53039700055

Application
NISSAN

OUR PRODUCTS



ENGINE

Frontier Pathfinder
Yo25

OEM No.
53039880338

MODEL: BV45
PART NO. 14411-5X30A

Application
NISSAN



ENGINE

ZD30D13-4N

OEM No.
14411-2DB1A

MODEL: GT2056S
PART NO. 775629-5002

Application
NISSAN



ENGINE

4D68

OEM No.
Mr355598

MODEL: TD04-9G
PART NO. 49177-02701

Application
MITSUBISHI

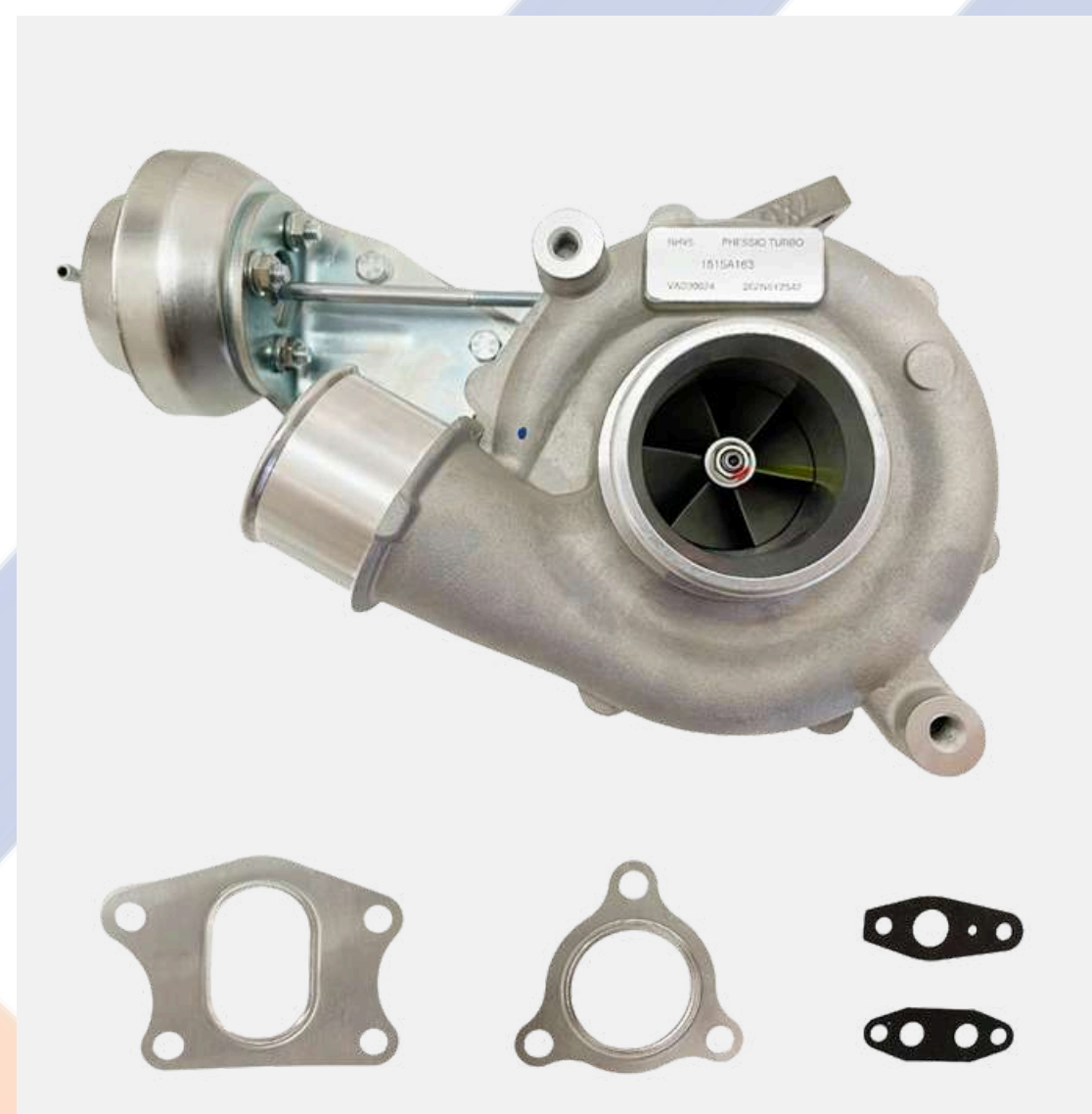

ENGINE

Shogun Pajero
IV 3.2

OEM No.

MODEL: VT13
PART NO. 1515A163

Application
MITSUBISHI



ENGINE

4D56

OEM No.
Mr355222

MODEL: TD04
PART NO. 49177-0150

Application
MITSUBISHI



ENGINE

4M50

OEM No.
Me223610

MODEL: TD04
PART NO. 49389-02042

Application
MITSUBISHI



ENGINE

4D31

OEM No.
Me080442

MODEL: TD05
PART NO. 49178-00510

Application
MITSUBISHI



ENGINE

6D31T SK200-3

OEM No.
Me088256

MODEL: TD06-17C
PART NO. 49179-02110

Application
MITSUBISHI

OUR PRODUCTS



ENGINE

Pajero 4M41

OEM No.

MODEL: TF035
PART NO. 49135-02910

Application
MITSUBISHI



ENGINE

Pajero 2.8L

OEM No.
49135-03100

MODEL: TF035HM-12T
PART NO. 49135-03101

Application
MITSUBISHI



ENGINE

6D31T

OEM No.
Me037701

MODEL: TD06
PART NO. 49179-00110

Application
MITSUBISHI



ENGINE

Kubota V2003t

OEM No.

MODEL: TD03-07T
PART NO. 49131-02030

Application
MITSUBISHI



ENGINE

Mitsubishi Td025m

OEM No.

MODEL: TD025M-05
PART NO. 49173-04100

Application
MITSUBISHI



ENGINE

Pajero 112.8TD

OEM No.
Me202578

MODEL: TF035
PART NO. 49135-03130

Application
MITSUBISHI



ENGINE

4M41

OEM No.
Me203949

MODEL: TF035HL
PART NO. 49135-03411

Application
MITSUBISHI



ENGINE

4D34T1

OEM No.
Me013134

MODEL: TD05H-12B
PART NO. 49178-02110

Application
MITSUBISHI

OUR PRODUCTS



ENGINE

6D15

OEM No.
Me073623

MODEL: TD06-4
PART NO.49179-00260

Application
MITSUBISHI



ENGINE

Excavator 6D31T

OEM No.
070145701H

MODEL: TE06-12M
PART NO. 49185-01010

Application
MITSUBISHI



ENGINE

6D16

OEM No.

MODEL: TD07S
PART NO. 49187-02710

Application
MITSUBISHI



ENGINE

Excavator 6D22T

OEM No.
Me050485

MODEL: TD08H-22D
PART NO. 49188-01651

Application
MITSUBISHI



ENGINE

6WF1

OEM No.
114400-3743

MODEL: TD08H
PART NO. 49188-01811

Application
MITSUBISHI

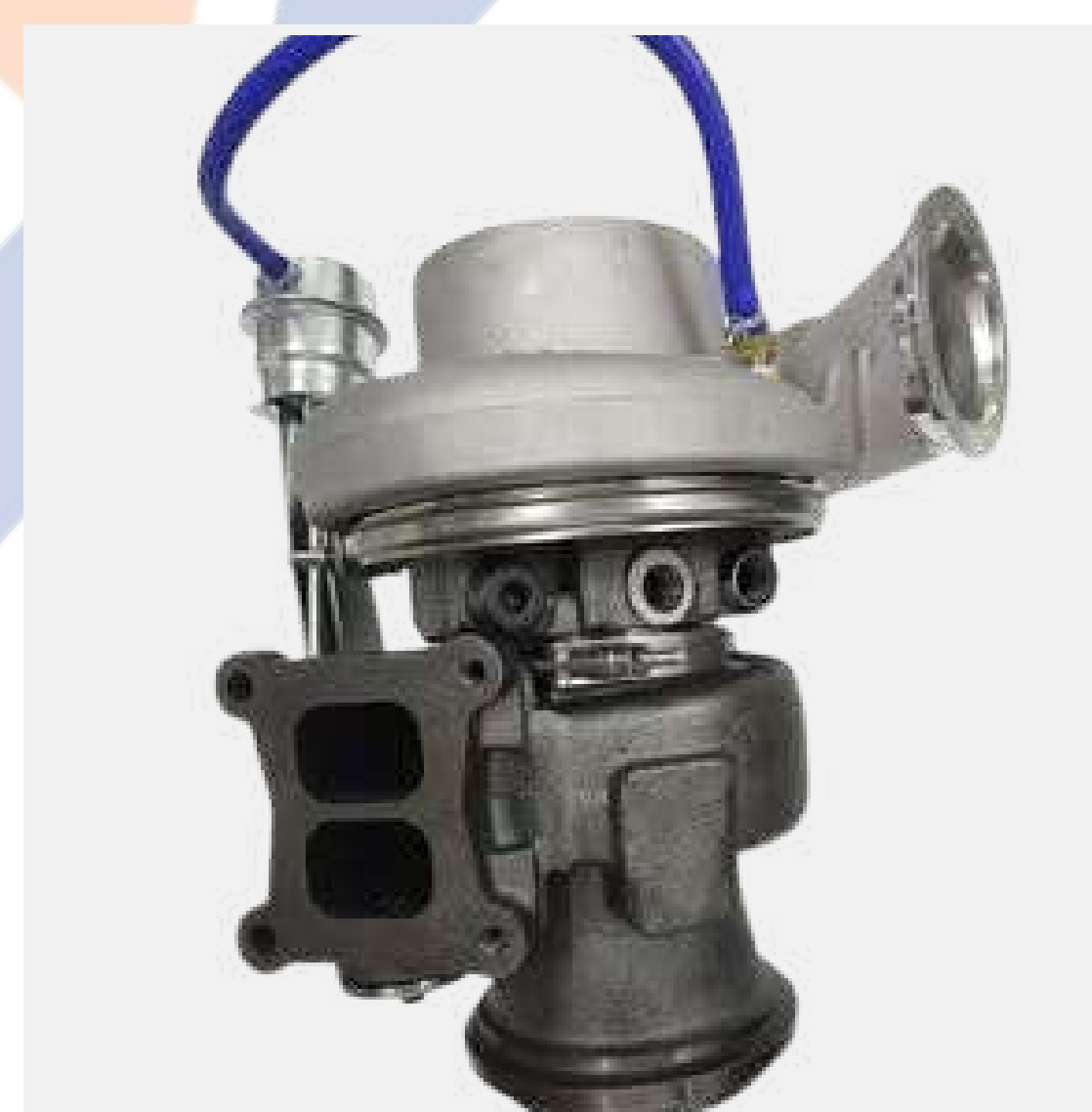

ENGINE

ruck Front- End Loader

OEM No.
4037635

MODEL: HX55W
PART NO. 4089863

Application
MEN



ENGINE

MAN 232 TRUCK
D0836LX LF1

OEM No.
51.09100-7448

MODEL: HX40
PART NO. 3591999

Application
MEN



ENGINE

Hiace 2L-T

OEM No.

MODEL: CT9
PART NO. 17201-64090

Application
MEN

OUR PRODUCTS



ENGINE

Truck D2542MLE

OEM No.
51.09100-7147

MODEL: 4LGZ
PART NO. 523297032793

Application
MEN



ENGINE

Mazda CX-7

OEM No.
5304109907

MODEL: K0422-582
PART NO. 53047109904

Application
MAZDA



ENGINE

B2500

OEM No.
W184

MODEL: RHF5
PART NO. VB430013

Application
MAZDA



ENGINE

Titan SLTP

OEM No.
SLTP13700

MODEL: HT15-01D
PART NO. 047-080

Application
TOYOTA



ENGINE

Bongo Passenger
16,0

OEM No.

MODEL: RHF3
PART NO. VB410084

Application
MAZDA



ENGINE

MAZDA 6

OEM No.
VHD20011

MODEL: RHV4
PART NO. VJ38

Application
MAZDA



ENGINE

6D16

OEM No.
Me073573

MODEL: TD07S
PART NO. 49187-01010

Application
MITSUBISHI



ENGINE

Discovery IV TDV6

OEM No.
Lr063777

MODEL: GT1444Z
PART NO. 778401-5004S

Application
LAND ROVER

OUR PRODUCTS



ENGINE

Discovery IV TDV6
GTB1749VK
OEM No.
Lr056369
MODEL: GTB1749VK
PART NO. 778400-5005S

Application
LAND ROVER



ENGINE

Land Rover
Discover/GEM
OEM No.
452055-5004S
MODEL: T250-4
PART NO. 452055-5004S

Application
LAND ROVER



ENGINE

Evoque 2.0
OEM No.
G4D36K682AG
MODEL: TD04
PART NO. 49335-01930

Application
LAND ROVER



ENGINE

Land-Rover Frebander
12.0L
OEM No.
7781450B
MODEL: GT1749V
PART NO. 708366-0001

Application
LAND ROVER



ENGINE

Evoque Freel 2.2L
OEM No.
Lr065510
MODEL: TD04L4
PART NO. 49477-01213

Application
LAND ROVER



ENGINE

Highlander Corona
Lexus NX 300
OEM No.
MODEL:
PART NO. 17201-36010

Application
LEXUS



ENGINE

Truck TGA420
OEM No.
53319887201
MODEL: K31
PART NO. 53319707201

Application
MAN



ENGINE

2066LF
OEM No.
51.09100-7598
MODEL: HX40W
PART NO. 3597501

Application
MAN

OUR PRODUCTS



ENGINE

B85J71GBQ

OEM No.
51.09100-7630

MODEL: HX40
PART NO. 4038409

Application
MAN



ENGINE

Sorento 2.5 CRDI

OEM No.
28200-4A470

MODEL: BV43
PART NO. 53039700122

Application
KIA



ENGINE

S6D105

OEM No.

MODEL: TO4B59
PART NO. 465044-0261

Application
KOMASTU



ENGINE

Excavator PC
100 200 128US

OEM No.
4089714

MODEL: HX25W
PART NO. 4038790

Application
KOMASTU



ENGINE

SAA6D125E-3K-8M

OEM No.

MODEL: S400
PART NO. 6156-81-8170

Application
KOMASTU



ENGINE

2-LT

OEM No.
6208-81-8100

MODEL: TD04L-10G
PART NO. 49377-01610

Application
KOMASTU



ENGINE

V2400-M-T-E3B-KEA-2

OEM No.

MODEL: TD03-07T
PART NO. 49131-02030

Application
KUBOTA



ENGINE

Various 4BT-110

OEM No.
3539846

MODEL: TD03-07T
PART NO. 3539803

Application
KOMASTU

OUR PRODUCTS



ENGINE

V3800

OEM No.
A6640900780

MODEL: TD04
PART NO. 1G574-17010

Application
KUBOTA



ENGINE

D1105

OEM No.
058145703J

MODEL: TD025
PART NO. 372A-111801BA

Application
KUBOTA



ENGINE

V2003-T

OEM No.
51.09100-7147

MODEL: RHF3.
PART NO. VB410140

Application
KUBOTA



ENGINE

Smart-MCC Smart
of 0,800

OEM No.
058145703J

MODEL: KP31
PART NO. 372A-111801BA

Application
BENZ



ENGINE

Om602

OEM No.

MODEL: GT2538C
PART NO. 454207-0001

Application
BENZ



ENGINE

OM422LA

OEM No.
40966099

MODEL: K27
PART NO. 53279706502

Application
BENZ



ENGINE

OM904LA

OEM No.
9040969199

MODEL: K16
PART NO. 53169707139

Application
BENZ



ENGINE

OM612 2.7L

OEM No.
6120960599

MODEL: GT2256V
PART NO. 715910-0001

Application
BENZ

OUR PRODUCTS



ENGINE

OM501LA-E4

OEM No.
53319706911

MODEL: K31
PART NO. 53319709606

Application
BENZ



ENGINE

OM924LA

OEM No.
9240961799

MODEL: K24
PART NO. 53249707114

Application
BENZ



ENGINE

OM501LA

OEM No.
60967399

MODEL:
PART NO. 316756

Application
BENZ



ENGINE

OM471

OEM No.
70967699

MODEL:
PART NO. 317471

Application
BENZ



ENGINE

OM444A

OEM No.
53339716000

MODEL: K33
PART NO. 53339716000

Application
BENZ



ENGINE

Truck, Bus J08C

OEM No.
479016-0002

MODEL: GT3576D
PART NO. 24100-3251C

Application
HINO



ENGINE

J05C

OEM No.
704409-0001

MODEL: GT3271S
PART NO. 24100-3530A

Application
HINO



ENGINE

J08C

OEM No.

MODEL: RHE62
PART NO. 24100-4151A

Application
HINO

OUR PRODUCTS



ENGINE

OEM No.

MODEL: HX40W
PART NO. 4051405

Application
HITACHI



ENGINE

6WF1

OEM No.
Va570090

MODEL: RHG6
PART NO. 114400-4380

Application
HITACHI



ENGINE

HINO PC11C

OEM No.
Vb730011

MODEL: RHE7
PART NO. 24100-2751B

Application
HINO



ENGINE

Rhc61A

OEM No.
704409-0001

MODEL: RHC61A
PART NO. 24100-1541A

Application
HINO

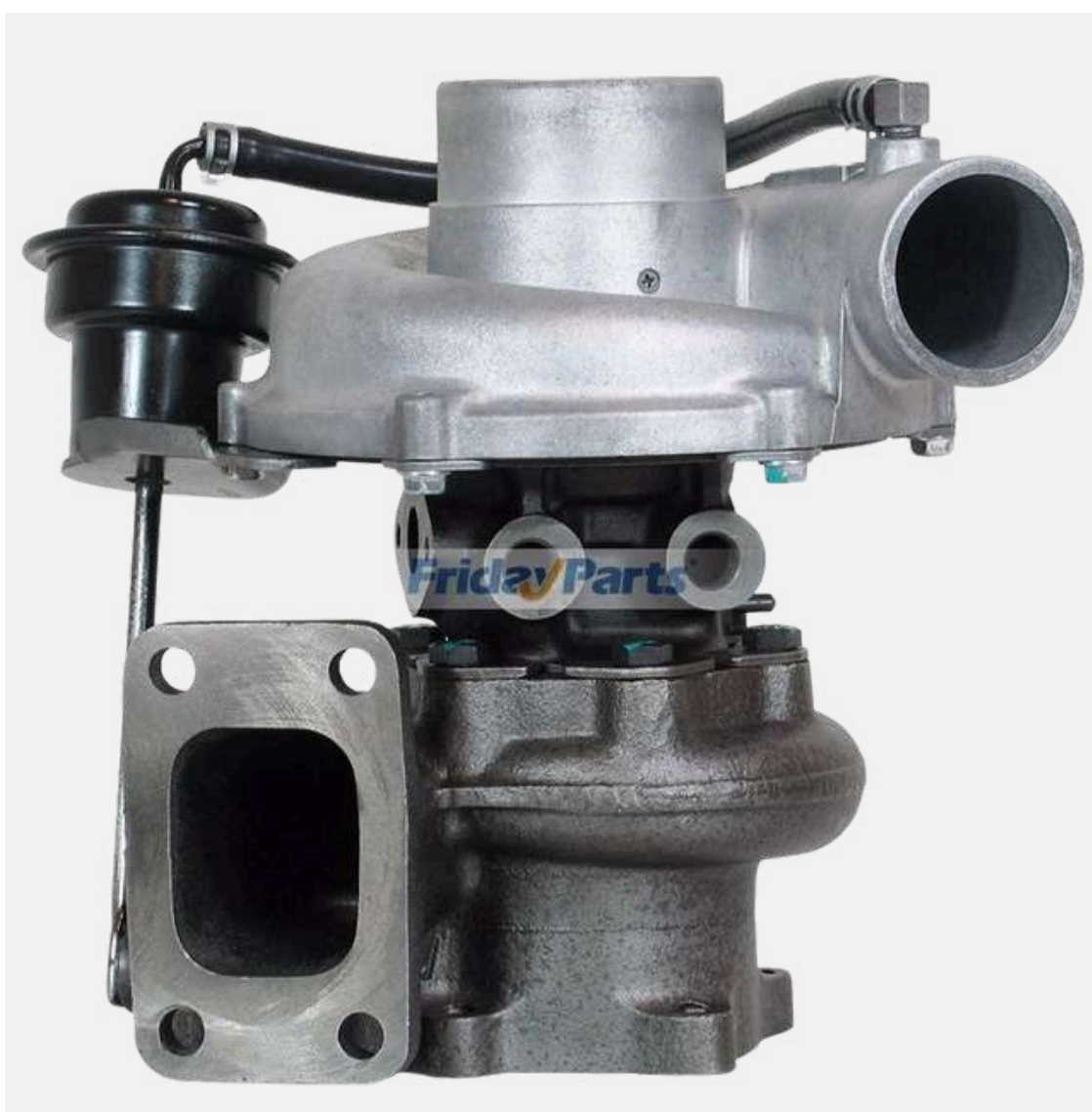

ENGINE

Yf20

OEM No.

MODEL: RHC6
PART NO. 24100-2201A

Application
HINO



ENGINE

4BD1-T

OEM No.

MODEL: RHB6
PART NO. 894418-3200

Application
HITACHI



ENGINE

6HK1

OEM No.
VA570033

MODEL: RHG6
PART NO. 114400-3900

Application
HITACHI



ENGINE

Cummins Dennis
Coach 15X12

OEM No.
4036758

MODEL: HX55W
PART NO. 4039494

Application
CUMMINS

OUR PRODUCTS



ENGINE

TRANSIT 2.2

OEM No.
6C1Q-6K682-CC

MODEL: TD03
PART NO. 49131-05310

Application
FORD



ENGINE

OEM No.
720618-0003

MODEL: TB25
PART NO.720618-5003

Application
FOTON



ENGINE

GW2.8T 2.8L

OEM No.
49135-06300

MODEL: TF035HM
PART NO. 1118100-E03

Application
Great Wall



ENGINE

GW491QE

OEM No.
1118100AED09

MODEL: TD025
PART NO. 49373-06010

Application
Great Wall



ENGINE

JO5E SK250-8

OEM No.
S1760-E0011

MODEL: GT2259LS
PART NO. 801644

Application
HINO



ENGINE

Ranger 2.2

OEM No.
BK3Q-6K682-NA

MODEL: TD03
PART NO. 49131-06320

Application
FORD



ENGINE

Fiat Alfa Romeo 2.0

OEM No.
55282309

MODEL: GTD1449VKZ
PART NO. 821785

Application
Flat Alfa ROMEO



ENGINE

HAVAL H5

OEM No.
1118100ED01A

MODEL: BV43
PART NO. 53039700168

Application
Great Wall

OUR PRODUCTS



ENGINE

N04C

OEM No.
17201-E0802

MODEL: GT2259LS
PART NO. 24100-1610

Application
HINO



ENGINE

HINO TRUCK

OEM No.
FB3Q-6K682-AB

MODEL: RHC6
PART NO. 24100-1610

Application
HINO



ENGINE

CUMMINS ISF 3.8

OEM No.
3772741

MODEL: HE200WG
PART NO. 3772742

Application
CUMMINS



ENGINE

CUMMINS ISF 3.8L

OEM No.
3774225

MODEL: HE211W
PART NO. 3774193

Application
CUMMINS

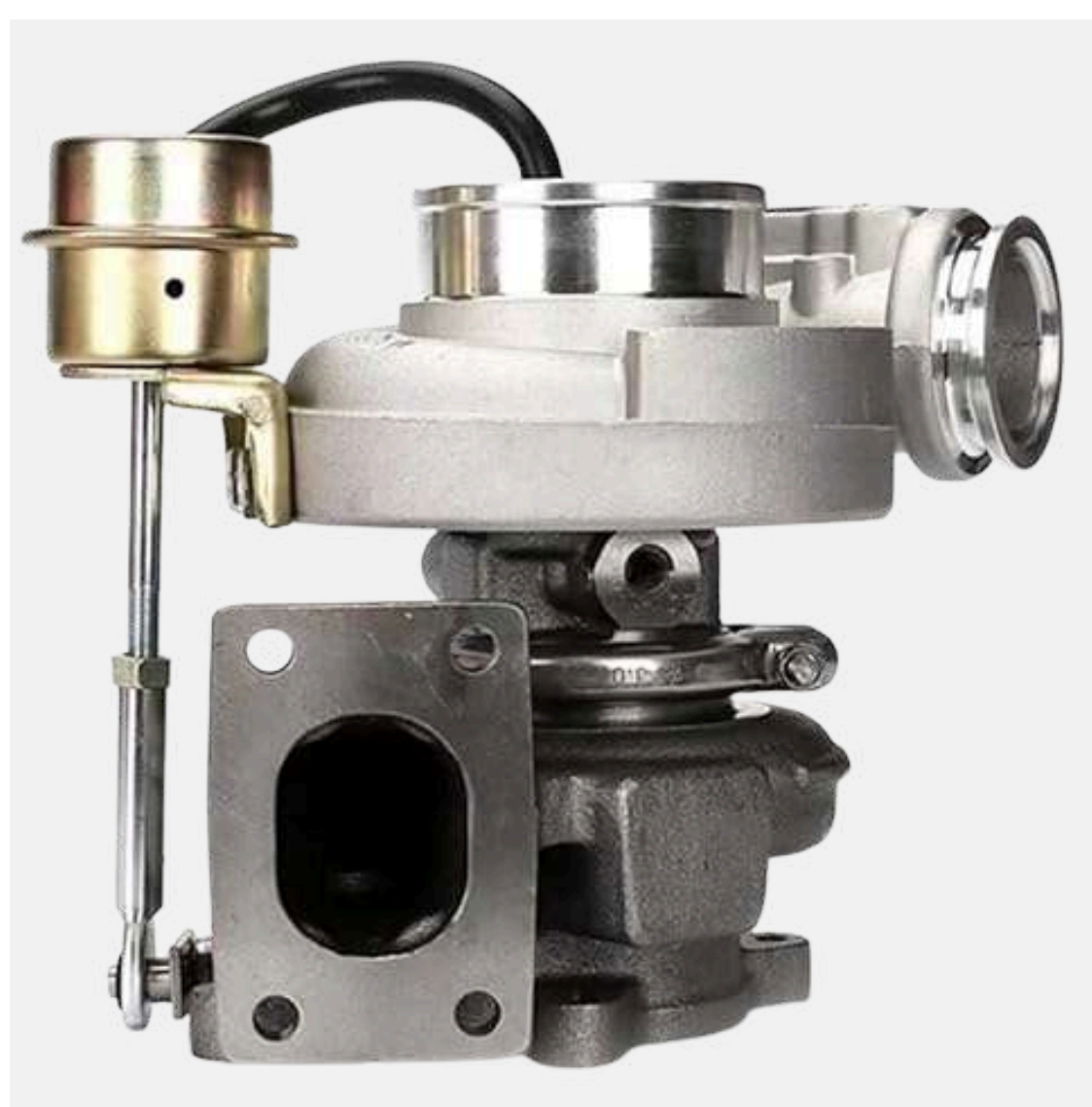

ENGINE

Various ISDE4

OEM No.
4956030

MODEL: HE211W
PART NO. 2835140

Application
CUMMINS



ENGINE

Cummins ISG3.8

OEM No.
2834188

MODEL: HE211W
PART NO. 3774229

Application
CUMMINS



ENGINE

Truck Crane ISM

OEM No.
3592783

MODEL: HX55W
PART NO. 4046025

Application
CUMMINS



ENGINE

Marine

OEM No.
3800852

MODEL: HX60
PART NO. 3592369

Application
CUMMINS

OUR PRODUCTS



ENGINE

Marine

OEM No.
3538623

MODEL: H2D
PART NO. 3802886

Application
CUMMINS



ENGINE

CUMMINS 6CAT 220PS

OEM No.
4029184

MODEL: HX40W
PART NO. 4029018

Application
CUMMINS



ENGINE

Detroit Series 60

OEM No.
23534775

MODEL: GTA4502V
PART NO. 758160-50075

Application
DETROIT



ENGINE

Detroit Series 60

OEM No.
070145701H

MODEL: GTA4294
PART NO. 714788-0001

Application
DETROIT



ENGINE

Lesion Cantine
Harvester We618

OEM No.

MODEL: GT45
PART NO. 723118-0001

Application
DAF



ENGINE

DEAWOO Truck DE
121S

OEM No.
65.09100-7196

MODEL: GT20
PART NO. 701139-0001

Application
DEAWOO



ENGINE

CZ

OEM No.

MODEL: CT12B
PART NO. 17201-64090

Application
CZ

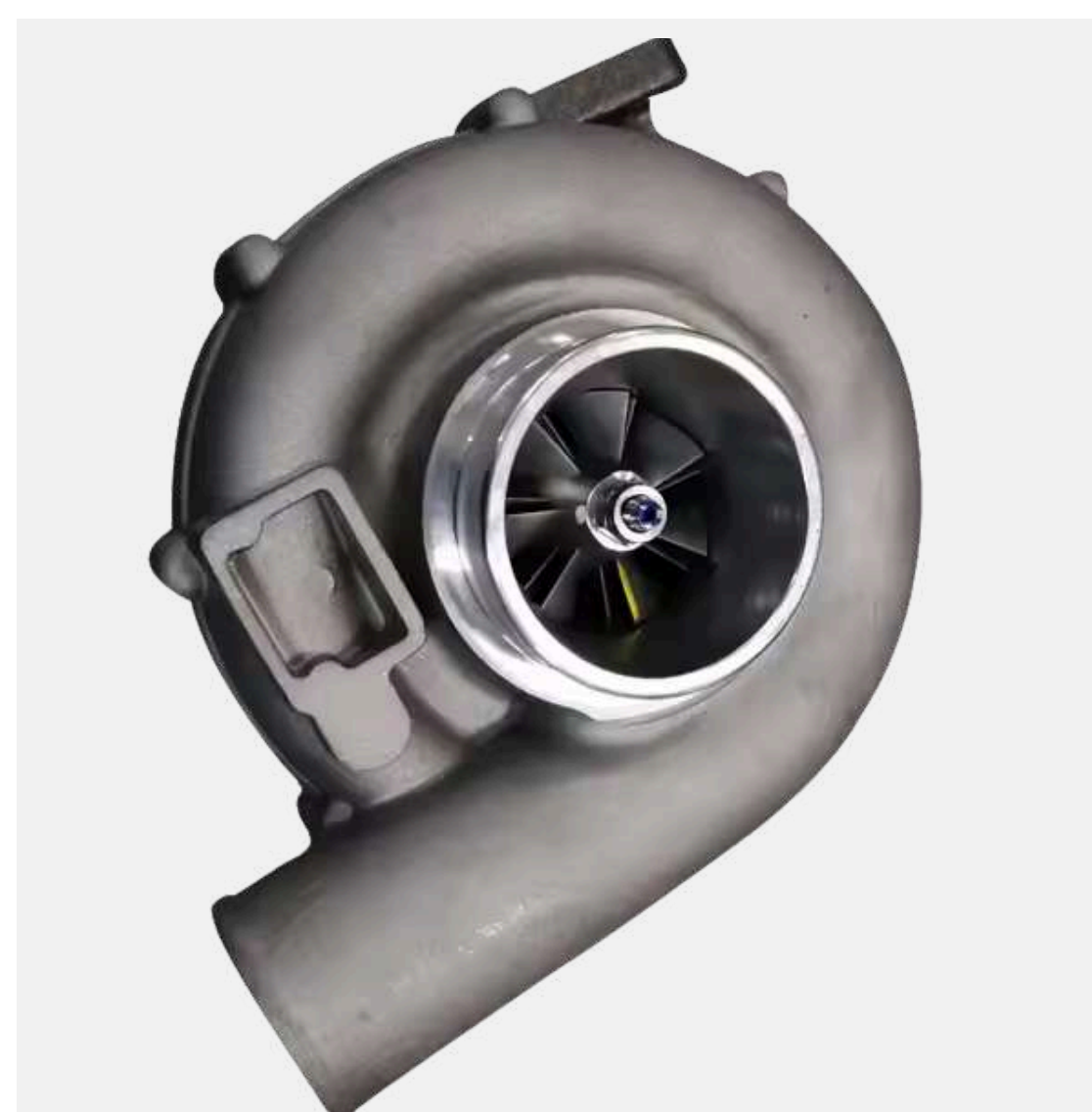

ENGINE

OM366A

OEM No.
3660961599

MODEL: K27
PART NO. 53279706441

Application
BENZ

OUR PRODUCTS



ENGINE

Audi A3

OEM No.
04E145715F

MODEL: TD025L4BR
PART NO. 49795-97601

Application
AUDI



ENGINE

Audi S3

OEM No.
070145701H

MODEL: IS38
PART NO. 06K145722H

Application
AUDI



ENGINE

Audi A4/A6 1.9L

OEM No.

MODEL: GT1749V
PART NO .701854-0002

Application
TOYOTA



ENGINE

Audi S3 1.8L

OEM No.
06A145704P

MODEL: KO4
PART NO. 53049700022

Application
AUDI



ENGINE

Audi A4 2.0

OEM No.
06D145701D

MODEL: KO3
PART NO. 53039700106

Application
AUDI



ENGINE

Audi A3 1.9L

OEM No.
038253019C

MODEL: GT1749V
PART NO. 713672-0002

Application
AUDI



ENGINE

Audi A3 1.8T

OEM No.
06A145704A

MODEL: KO3
PART NO.
532040000000

Application
AUDI



ENGINE

Audi A3

OEM No.
53279706206

MODEL: KO3
PART NO. 53279706206

Application
AUDI

OUR PRODUCTS



ENGINE

AUDI A3

OEM No.
038145701A

MODEL: KO3
PART NO.53039700015

Application
AUDI



ENGINE

Mustang 2.3L L4

OEM No.
FR3E-9G438-CC

MODEL: GT2260S
PART NO. 821402

Application
FORD



ENGINE

S350

OEM No.
DP2-6K682-AC

MODEL: GTC15
PART NO. 809415-0004

Application
FORD



ENGINE

Transit 2.2 TDCI

OEM No.
BK3Q6K682CC

MODEL: GTB1749V
PART NO. 787556

Application
FORD



ENGINE

FORD RANGER PUMA
22

OEM No.
FB3Q-6K682-AB

MODEL: GTD1449V
PART NO. 831157

Application
FORD



ENGINE

WLAA

OEM No.
03051M

MODEL: RHV4
PART NO. VHD20011

Application
FORD



ENGINE

NGD 3.0

OEM No.
Ex79526

MODEL: GT25S
PART NO. 754743-5001S

Application
FORD



ENGINE

HS2.8 HT

OEM No.
79517

MODEL: GT2260V
PART NO.724652-0001

Application
FORD

OUR PRODUCTS



ENGINE

Ford Ranger/Everest
3.2

OEM No.
FB3Q-6K682-PC

MODEL: GTD2056V
PART NO. 822182

Application
FORD



ENGINE

ISBE4

OEM No.
172198

MODEL: K16
PART NO. 53169887215

Application
FORD



ENGINE

TRANSIT 2.4

OEM No.
1406162

MODEL: TD03
PART NO. 49131-05400

Application
FORD



ENGINE

FORD Ranger HS2.8

OEM No.

MODEL: GT2052S
PART NO. 721843-0001

Application
FORD



ENGINE

LAND-ROVER 2.4 TDCI

OEM No.

MODEL: GTA2052V
PART NO. 752610-0010

Application
FORD



ENGINE

TRUCK Navistar F250
350

OEM No.
452213-0003

MODEL: GT1549S
PART NO. 452213-0001

Application
FORD



ENGINE

OEM No.
73501343

MODEL: KP35
PART NO. 54359700005

Application
FIAT



ENGINE

ISB6

OEM No.
4089673

MODEL: HE351CW
PART NO. 4043600

Application
DODGE

OUR PRODUCTS



ENGINE

TCD2013L04

OEM No.
4294260

MODEL: B1G
PART NO. 11589880000

Application
DEUTZ



ENGINE

BF4M2012C

OEM No.
4254347

MODEL: CT26
PART NO.318279

Application
DEUTZ



ENGINE

Industrial TARCTOR
TC201306

OEM No.
2709880013

MODEL: S200G
PART NO. 04903626KZ

Application
DEUTZ

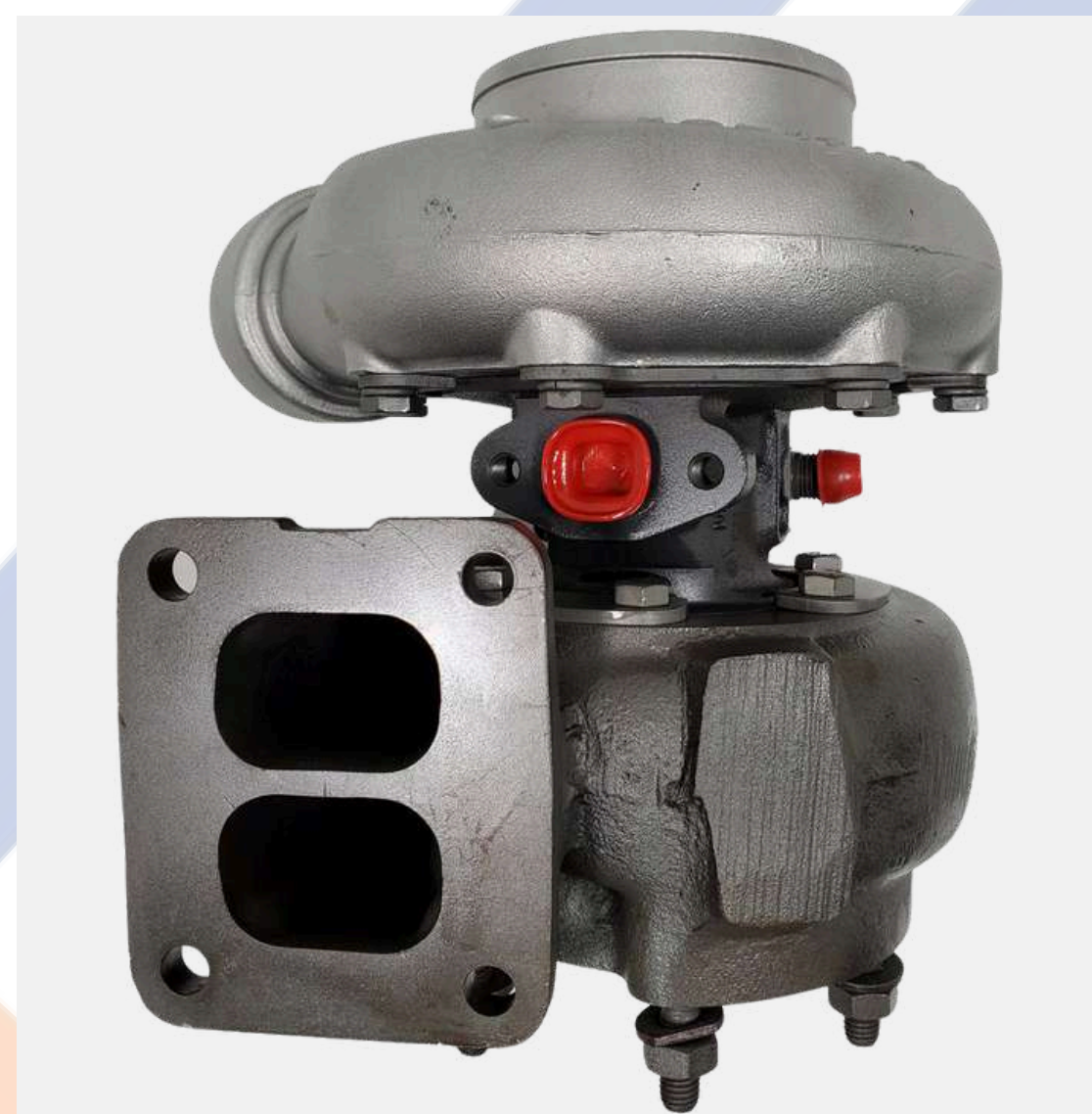

ENGINE

Truck Euro 2 bm1015

OEM No.
04226496KZ

MODEL: CT9
PART NO. 317772

Application
DEUTZ



ENGINE

Caterpillar Or7009

OEM No.
125-1123

MODEL: 3116T
PART NO. 1251123

Application
KOMATSU



ENGINE

Industrial with V3800

OEM No.
1J583-17014

MODEL: TF035HM
PART NO. 1J508-17014

Application
KUBOTA



ENGINE

Pegasus, QSC8.3

OEM No.
4043580

MODEL: HX55WM
PART NO. 4043504

Application
CUMMINS



ENGINE

Cummins QSL9.3

OEM No.
3799505

MODEL: HE400WG
PART NO. 3799504

Application
CUMMINS

OUR PRODUCTS



ENGINE

Deutz BF6L913

OEM No.
04232274

MODEL: BF6L912
PART NO.04232254

Application
DEUTZ



ENGINE

TAMD163A, TAMD165A-A

OEM No.
3825186

MODEL: S4TW
PART NO. 314756

Application
VOLVO



ENGINE

TAMD 120B, TAMD 122A

OEM No.
3802018

MODEL: 4LGK
PART NO. 3503776

Application
VOLVO



ENGINE

NSN 2920-01-552-1355

OEM No.
203539920209

MODEL: 313029022067
PART NO. 5521355

Application
MAZDA



ENGINE

Kamaz 536

OEM No.
53604.1118010

MODEL: B2CG
PART NO. 12589700113

Application
KAMAZ



ENGINE

Perkins Vista 6

OEM No.
10R4752

MODEL: GT3571S
PART NO. 220-8182

Application
CATERPILLAR



ENGINE

Starex D4CB

OEM No.
28200-4A001

MODEL: GT1752S
PART NO. 710060-5001S

Application
HYUNDAI



ENGINE

SORENTO 2.5 CRDI

OEM No.
53039700144

MODEL: BV43
PART NO. 28200-4A470

Application
HYUNDAI

OUR PRODUCTS



ENGINE

Truck D4AL

OEM No.
708337-0002

MODEL: GT1749S
PART NO. 28230-41730

Application
HYUNDAI



ENGINE

Matrix Getz

OEM No.
28201-2A100

MODEL: GT1544V
PART NO. 782403-0001

Application
HYUNDAI



ENGINE

Matrix 1.5 CRDI

OEM No.
49173-02622

MODEL: TD02
PART NO. 28231-27500

Application
HYUNDAI

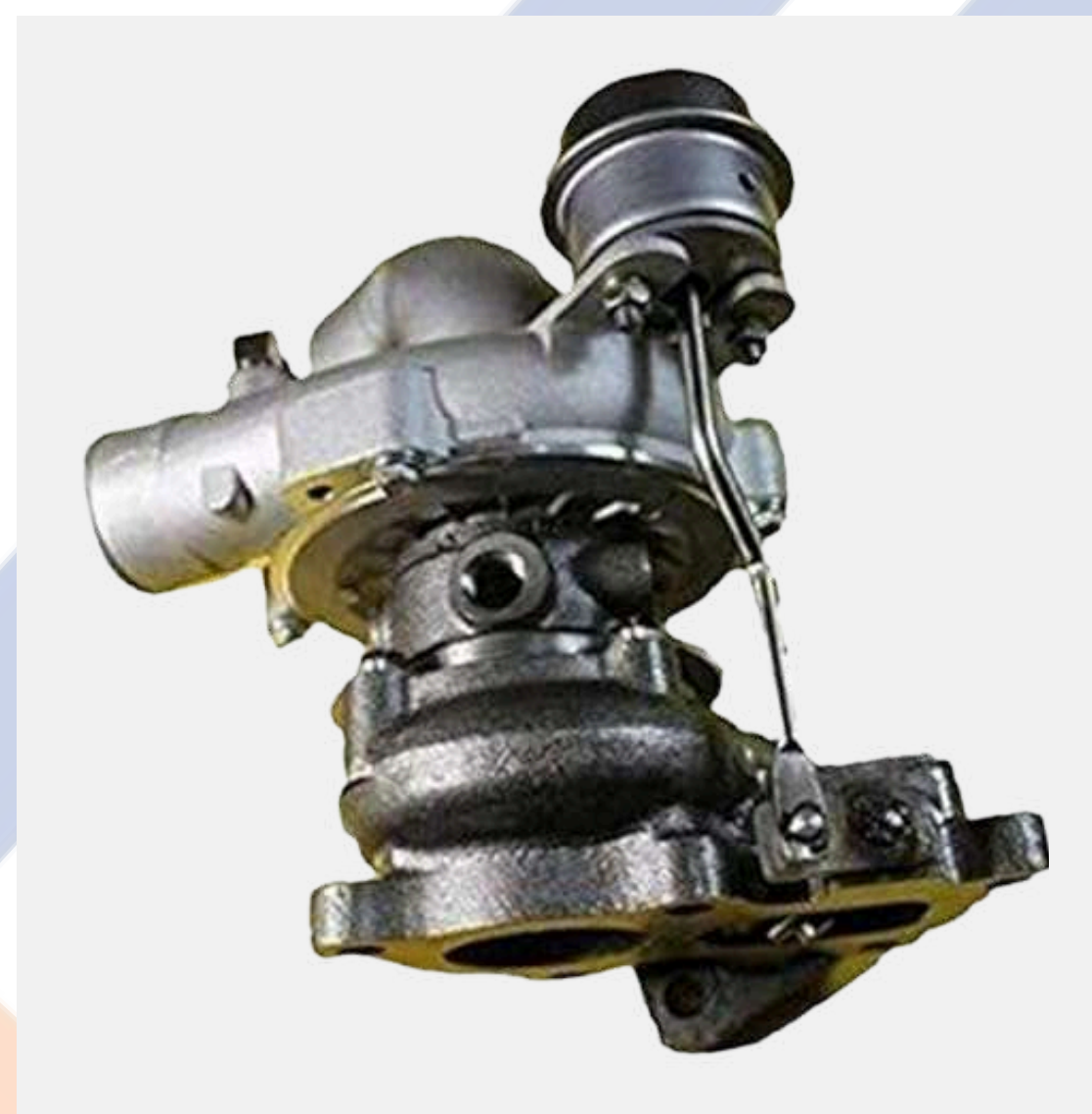

ENGINE

D4BH

OEM No.
28200-42600

MODEL: GT1749S
PART NO. 715843-5001S

Application
HYUNDAI



ENGINE

Grand Starex D4CB

OEM No.
53039700145

MODEL: BV43
PART NO. 28200-4A480

Application
HYUNDAI



ENGINE

2-LT

OEM No.
28200-4A350

MODEL: GT20
PART NO. 17201-54060

Application
HYUNDAI



ENGINE

4D56T

OEM No.
28200-4B160

MODEL: GT1749S
PART NO. 700273-0002

Application
HYUNDAI



ENGINE

OEM No.

MODEL: GT2052S
PART NO. 28230-41001

Application
TOYOTA

OUR PRODUCTS

ENGINE

Valtra Bf75

OEM No.
836659179

MODEL: S1B
PART NO. 315921

Application
JOHN DEERE



ENGINE

John Deere model 9500

OEM No.

MODEL: T04E48
PART NO. 465637-0001

Application
JOHN DEERE



ENGINE

PICNIC 3CTE

OEM No.

MODEL: K27-115-02
PART NO. 96937611118

Application
KAMAZ



ENGINE

Industrial Gen Set

OEM No.
53369886500

MODEL: K36-8701
PART NO. 53369706500

Application
KAMAZ



ENGINE

Kamaz 740, 30, 31

OEM No.
K27-145-01

MODEL: K27
PART NO. 3990023145

Application
KAMAZ



ENGINE

Retona Sportage 2.0

OEM No.

MODEL: KT10-1B
PART NO. 0K05813700C

Application
KIA



ENGINE

Kia Sorento2, 5 CRD

OEM No.
28200-4A101

MODEL: GT1752S
PART NO. 733952-5004S

Application
KIA



ENGINE

Elantra 2.0 CRDI

OEM No.
49173-02410

MODEL: TD025
PART NO. 28231-27000

Application
KIA



OUR PRODUCTS



ENGINE

TD12.5L 4D56

OEM No.
A6640900780

MODEL: TF035HM
PART NO. 28200-4A201

Application
KIA



ENGINE

KIA BONGO K2500

OEM No.

MODEL: TD03L
PART NO. 28231-4A800

Application
KIA



ENGINE

D4EB

OEM No.
28231-278810

MODEL: TF035HL
PART NO. 49135-07312

Application
HYUNDAI

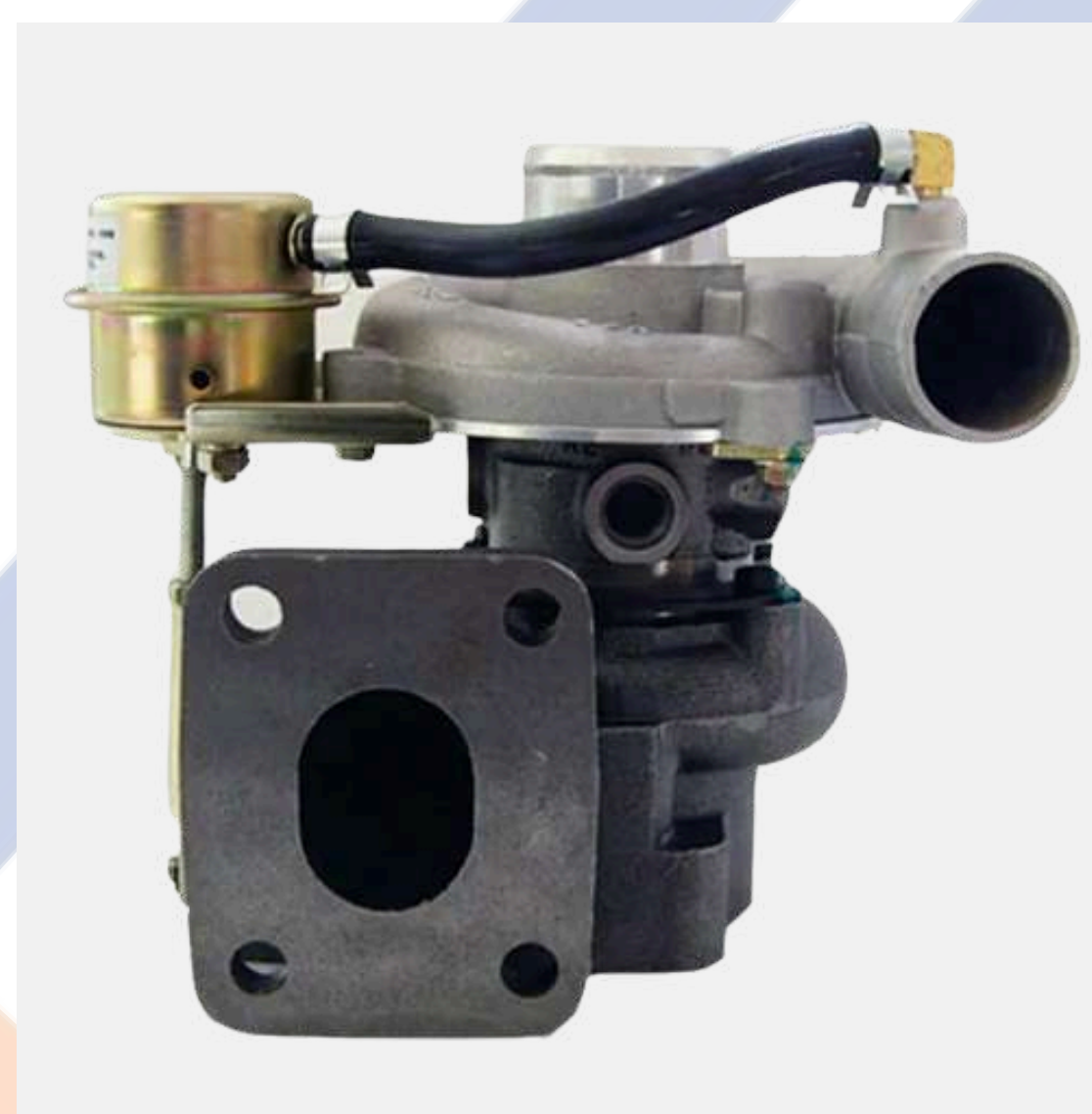

ENGINE

D4AE

OEM No.
28230-41422

MODEL: GT17495
PART NO. 471037-0002

Application
HYUNDAI



ENGINE

4D56T

OEM No.
716938-0001

MODEL: GT1749S
PART NO. 28200-42560

Application
HYUNDAI



ENGINE

Gemini 1.5L

OEM No.
Vb110094

MODEL: RHB32
PART NO. 8970786400

Application
ISUZU



ENGINE

4JB1T

OEM No.

MODEL: RHB5
PART NO. 8971760801

Application
ISUZU



ENGINE

Grand Starex 1.5L

OEM No.
49135-04350

MODEL: GT1749S
PART NO. 28200-42800

Application
HYUNDAI

OUR PRODUCTS



ENGINE

4D56T

OEM No.
08200-4A200

MODEL: TF035
PART NO. 49135-04020

Application
HYUNDAI



ENGINE

4D34

OEM No.
49178-03123

MODEL: TD05H-14G
PART NO. 28230-45100

Application
HYUNDAI



ENGINE

4JB1TC/2.5L

OEM No.

MODEL: RHF5
PART NO. 8973311850

Application
ISUZU



ENGINE

D-MAX2.5

OEM No.
070145701H

MODEL: RHF5
PART NO. 8972402101

Application
ISUZU



ENGINE

Daily II12.8L

OEM No.
5001851014

MODEL: GT2256V
PART NO. 751578-5002

Application
IVECO



ENGINE

Daily

OEM No.
5001851014

MODEL: GT2056S
PART NO. 751578-5002

Application
IVECO



ENGINE

Iveco Cursor 13.10 Truck

OEM No.
3594875

MODEL: HY55V
PART NO. 504003367

Application
IVECO



ENGINE

Jac refine 1.9t

OEM No.

MODEL: GT1749V
PART NO. 777218-0002

Application
JAC

OUR PRODUCTS



ENGINE

S5-L21872

OEM No.
53039880354

MODEL: K03
PART NO. 53039880354

Application
JAC



ENGINE

John Deere 4239T 39174

OEM No.
28200-4A101

MODEL: CT26
PART NO. 733952-5004S

Application
JOHN DEERE



ENGINE

4045T

OEM No.
28200-4A101

MODEL: S1B
PART NO. 733952-5004S

Application
JOHN DEERE



ENGINE

HOHN DEERE TRACTOR

OEM No.
Ar63779

MODEL: TA3401
PART NO.409250-0002

Application
JOHN DEERE



ENGINE

Tractor4455

OEM No.

MODEL: T04E45
PART NO.465355-50018

Application
JOHN DEERE



ENGINE

OEM No.
Re16964

MODEL: TB4129
PART NO.466608-5001

Application
JOHN DEERE



ENGINE

4HG1

OEM No.
704136-0001

MODEL: GT2256MS
PART NO. 8973267520

Application
ISUZU



ENGINE

6HE1

OEM No.
Va720101

MODEL: RHE6
PART NO. 8981534800

Application
ISUZU

OUR PRODUCTS



ENGINE

4JJ1T

OEM No.
V430144

MODEL: RHF5
PART NO. 8980540111

Application
ISUZU



ENGINE

VIGA

OEM No.
V440056

MODEL: RHF55
PART NO. 8980701432

Application
ISUZU



ENGINE

4HE1T

OEM No.
Vc440012

MODEL: RHF55
PART NO. 8971038570

Application
ISUZU



ENGINE

4JJ1E4N

OEM No.
VEA30023

MODEL: RHF5V
PART NO. 8973815070

Application
ISUZU



ENGINE

4JK1-TC

OEM No.

MODEL: RHF3
PART NO. 8981506872

Application
ISUZU



ENGINE

Iveco Daly 112.8

OEM No.
99450703

MODEL: TF035HM
PART NO. 49135-05000

Application
IVECO



ENGINE

Commercial 440.2300E

OEM No.
500364493

MODEL: GT17
PART NO. 53039700081

Application
IVECO



ENGINE

OEM No.
4032312

MODEL: 4LGK
PART NO. 3525178

Application
IVECO

OUR PRODUCTS



ENGINE

TRUCK Trooper 4JB1T

OEM No.
Va430016

MODEL: RHF5
PART NO. 8971195672

Application
ISUZU



ENGINE

OEM No.
Vc20094

MODEL: RHC7
PART NO. 8943944573V

Application
ISUZU



ENGINE

D-MAXFE-1106 3.0L

OEM No.
8980118923

MODEL: RHC7
PART NO. 8980118922

Application
ISUZU



ENGINE

4HK1

OEM No.
135756180

MODEL: RHF4
PART NO. VA420081

Application
ISUZU



ENGINE

4JJ1

OEM No.
Va430101

MODEL: RHF5
PART NO. 8980198930

Application
ISUZU



ENGINE

Truck 4HK1

OEM No.
Re16964

MODEL: RHF4
PART NO. 8981941890

Application
ISUZU



ENGINE

4HE1

OEM No.
700716-0009

MODEL: G125
PART NO. 8972089663

Application
ISUZU



ENGINE

Zx450 6WG1X

OEM No.
114400-4441

MODEL: TD08H-31M
PART NO. 49188-01832

Application
ISUZU

OUR PRODUCTS



ENGINE

TURCK 6RB1

OEM No.
114400-3400

MODEL: TA5131
PART NO. 466569-5001S

Application
ISUZU



ENGINE

Aus Trado4 44400con 4
Cine

OEM No.
466898-0006

MODEL: TB2518
PART NO. 8944805870

Application
ISUZU



ENGINE

Caterpillar C-15 15.0L

OEM No.
10R2622

MODEL: GTA5008
PART NO. 240-0003

Application
CATERPILLAR



ENGINE

DDC-MTU 12V4000

OEM No.
23540088

MODEL: BTV7501
PART NO. 5260200805

Application
MTU



ENGINE

OEM No.
21989961

MODEL: HE500WG
PART NO. 5456125

Application
VOLVO



ENGINE

Caterpillar Cat Excavator
350

OEM No.
CA5947756

MODEL:
PART NO. 594-7756

Application
CATERPILLAR



ENGINE

1106D engine and
the Caterpillar C6.6

OEM No.
1070-0002

MODEL: B2G
PART NO. 2674A256

Application
PERKINS



ENGINE

PENTA D6-330A-F

OEM No.
3802151

MODEL: K27
PART NO. 53279707500

Application
VOLVO

OUR PRODUCTS



ENGINE

QSM11 CM876 M101

OEM No.
5609147X

MODEL: HX55
PART NO. 5609146

Application
MTU



ENGINE

OEM No.
22233319

MODEL: A40G
PART NO. 22918827

Application
VOLVO



ENGINE

Volvo MD11

OEM No.
2674A055

MODEL: HE500
PART NO. 452058-0002

Application
VOLVO



ENGINE

OM460HLA

OEM No.

MODEL: S410
PART NO. 14879880001

Application
MERCEDES



ENGINE

1004.4THR2

OEM No.
2674A055

MODEL - TB2556
PART NO. 452058-0002

Application
PERKINS



ENGINE

Volvo D12

OEM No.
11423338

MODEL: HX55
PART NO. 11423684

Application
VOLVO



ENGINE

332E

OEM No.
6156818150

MODEL: WA450
PART NO. 6506-21-5010

Application
KOMATSU



ENGINE

4TNV94FHT

OEM No.

MODEL: RHF5
PART NO. MIA884648

Application
JOHN DEERE

OUR PRODUCTS



ENGINE

OEM No.
8973267520

MODEL: GT2256LMS
PART NO. 704136-5003S

Application
ISUZU



ENGINE

S200

OEM No.
04258309KZ

MODEL: BF6M2012C
PART NO. 3531667

Application
FORD



ENGINE

4.0L Hino N04C

OEM No.
806883-0001

MODEL: HINO300
PART NO. 17201-E0803

Application
TOYOTA



ENGINE

Engine 6BTA Turbo HX35

OEM No.

MODEL: HX35W
PART NO. 3802881

Application
CUMMINS



ENGINE

Cursor 13 F3B Euro-3

OEM No.
504004853

MODEL: KP35
PART NO. 4046945

Application
IVECO

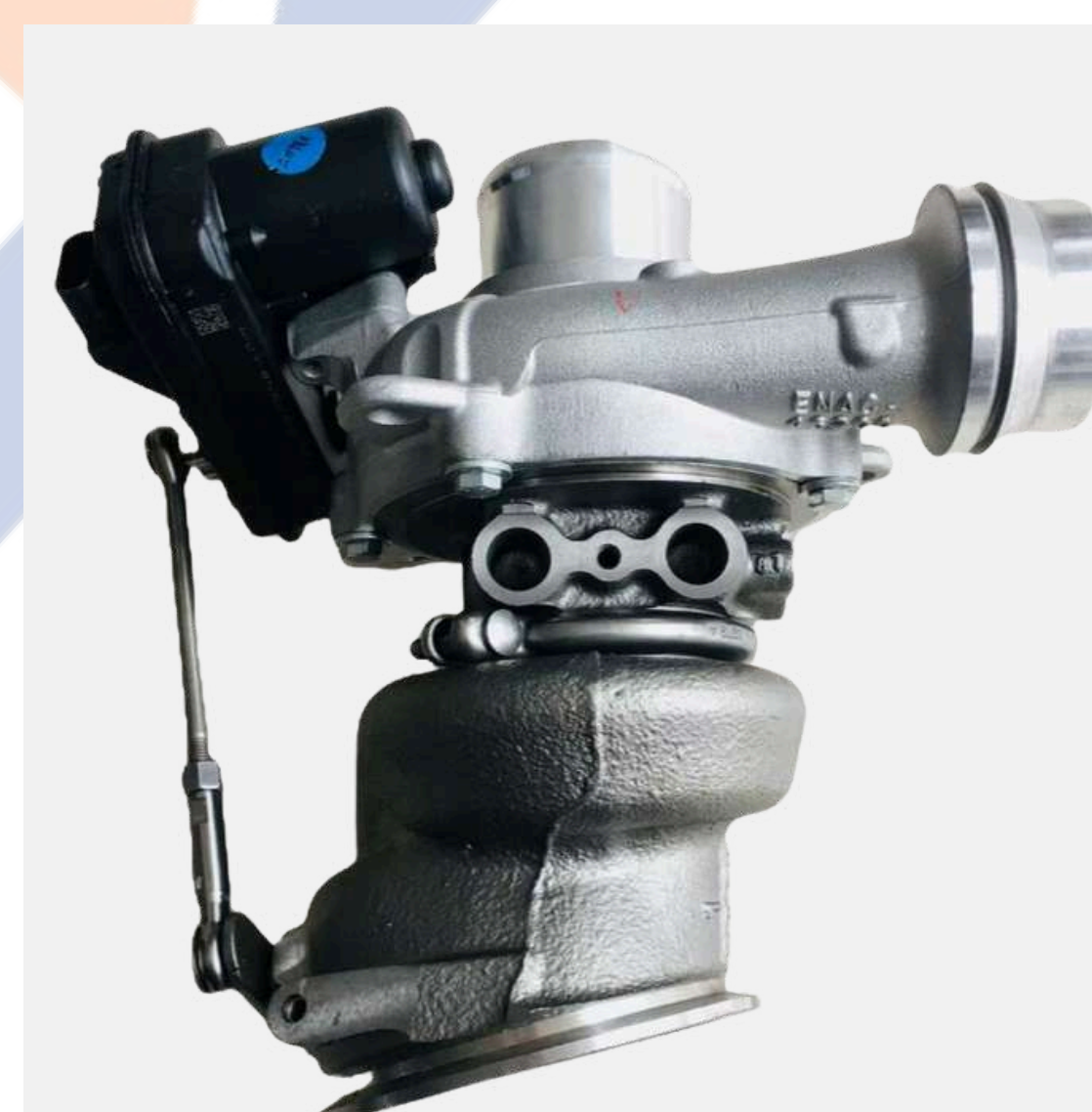

ENGINE

Jaguar 2.0 240/250 BHP

OEM No.
3039700581

MODEL: B03G
PART NO. 18489700015

Application
LAND ROVER



ENGINE

TD04L6-04H

OEM No.
12674684

MODEL:
PART NO. 49377-07850

Application
MITSUBISHI



ENGINE

VA290051

OEM No.
11957818010

MODEL: RHC7
PART NO. 119578-18010

Application
YANMAR

OUR PRODUCTS



ENGINE

OEM No.
570914510107

MODEL:
PART NO. 415529021469

Application
TATA MOTORS



ENGINE

Garrett Detroit Diesel
V71, V92

OEM No.
R5199305

MODEL: 8V71TI
PART NO. 5143110

Application
DETROIT



ENGINE

6.8L 6068, 6068HL285,
and 6068HYH01

OEM No.

MODEL: 200D
PART NO. RE550941

Application
JOHN DEERE



ENGINE

John Deere 4-219
and 4-276T

OEM No.
AR70439

MODEL: 410B, 450D
PART NO. AR70439

Application
JOHN DEERE



ENGINE

CAT 3044C and C3

OEM No.
2354964

MODEL: 246B, 267B, 277
PART NO. 235-4964

Application
CATERPILLAR



ENGINE

CAT 3204

OEM No.
OR5824

MODEL: T04B65
PART NO. 6N8477

Application
CATERPILLAR



ENGINE

C7.1

OEM No.
3590128

MODEL: GT3782
PART NO. 359-0128

Application
CATERPILLAR



ENGINE

CAT C6.6 C7.1

OEM No.

MODEL: GT2560S
PART NO. 3535972

Application
CATERPILLAR

OUR PRODUCTS



ENGINE

TD04L4-09TK3

OEM No.

MODEL: TD04L4
PART NO. 436-1920

Application
CATERPILLAR



ENGINE

Doosan D24

OEM No.
795787-5016S

MODEL: GT1241Z
PART NO.7030304

Application
DOOSAN



ENGINE

IT62 C7 7.0LTR

OEM No.
10R6465

MODEL: 950H, 962H
PART NO. 250-0841

Application
CATERPILLAR



ENGINE

OEM No.
GTD1749

MODEL: GTD1749
PART NO. 835406-0012

Application
HYUNDAI



ENGINE

BMW B38B15A

OEM No.
11657633795

MODEL:
PART NO. 7633795

Application
BMW



ENGINE

CRV Civic 1.5 TL
15B7 2SV 2HX

OEM No.
189005AAA01

MODEL: 2SV, 2HX
PART NO. 49373-07011

Application
HONDA



ENGINE

406B, 3406C
C15, SR4 generator

OEM No.
1108463

MODEL: 3406B 3406C
PART NO. 110-8463

Application
CATERPILLAR



ENGINE

C7.1

OEM No.
11R1943

MODEL:
PART NO. 635-6092

Application
CATERPILLAR

OUR PRODUCTS



ENGINE

Eicher 6 Cyl Bsiv

OEM No.

MODEL: ID322400
PART NO. 125929020595

Application
EICHER



ENGINE

Cherokee 2.5L Crd

OEM No.
28200-4A101

MODEL: VA76
PART NO. 35242167F

Application
CHEROKEE



ENGINE

Detroit Diesel 12.7L
Series 60

OEM No.

MODEL: S1B
PART NO. 733952-5004S

Application
HOLSET



ENGINE

Caterpillar D4H 3304

OEM No.
4N6859

MODEL:
PART NO. 4N6859

Application
CATERPILLAR



ENGINE

S2E

OEM No.
OR6629

MODEL: 3116/960F
PART NO. 1028410

Application
CATERPILLAR



ENGINE

2.5L Crd Engine

OEM No.
35242167F

MODEL: RHF4
PART NO. 35242167F

Application
MAZDA



ENGINE

F1c / 4p10t2 / 4p10t6

OEM No.
789773-5030S

MODEL: GTB2056V
PART NO. 789773-5033S

Application
MITSUBISHI



ENGINE

CAT C7 3126E

OEM No.

MODEL:
3126/3126B/3126E/C7
PART NO. 1918019

Application
CATERPILLAR

OUR PRODUCTS



ENGINE

OEM No.
49185-01050

MODEL: SK200-6E
PART NO. ME441234

Application
MITSUBISHI



ENGINE

IVECO Daily 3.0 F1C

OEM No.
49189-02913

MODEL: TD04HL
PART NO. 504340177

Application
IVECO



ENGINE

Qsb6.7 6CT Hx35W

OEM No.
4038598

MODEL: S1B
PART NO. 4038211

Application
CUMMINS



ENGINE

s200 deutz / volvo
penta industrial 6ltr

OEM No.
04282637kz

MODEL: S200
PART NO. 318706

Application
VOLVO



ENGINE

OEM No.
13769880037

MODEL:
PART NO. 1376970037

Application
BORG WARNER



ENGINE

TD09L-34QRC

OEM No.

MODEL: 4016-61TRG2
PART NO. SE652CW

Application
PERKINS



ENGINE

OEM No.
1000859795

MODEL: N350
PART NO. 1000859795

Application
JAC



ENGINE

OEM No.
53039880098

MODEL: RHE6
PART NO. 53039700098

Application
CHEVROLET

ZIEDDEL



Volkswagen



CATERPILLAR



+91 84549 13166

sales@ziedel.com

<https://ziedel.com/>

DANDONG BOOST TURBO CO.LTD, 152-1, Jinshan Industrial Area, Guncheng Village Xiangyang, Dandong City Liaoning Province, CHINA – 118100.